

design: R&D

# A3 - 65

# A3 - E

**LAM32**  
IDEASBECOMINGLIGHT

Sistema da rasare e tinteggiare, pensato per installazione ad incasso a scomparsa su spigoli di soffitti e pareti realizzati in cartongesso. Finalizzato all'impiego di sorgenti LED di diversa potenza, ha corpo realizzato in alluminio estruso anodizzato completamente riempito di speciale resina opale resistente ai raggi UV, per garantire il massimo livello di performance, comfort visivo e pulizia nel tempo. Tappi terminali di chiusura in alluminio anodizzato. L'apparecchio è fornito con uscita del cavo di alimentazione posteriore. Dotato di 50 cm di cavo per il collegamento alla linea di alimentazione 24VDC. Alimentatore elettronico 24VDC da ordinare come accessorio.

*The smoothing and painting system is designed for recessed flush installation on plasterboard ceilings and walls edges. Luminaire designed for recessed installation on false ceilings using appropriate accessories. Suitable for LED sources of different powers, their bodies is made of anodized extruded aluminium, full filled with a special opal resin, resistant to UV rays, to ensure the maximum level of performance, visual comfort and cleanness over time Closing end caps are made of anodized aluminium. The luminaires are supplied with rear cable output. It is equipped with a 50cm long cable for connection to the 24VDC power supply line. 24VDC Electronic driver to be ordered as an accessory.*

# A3-65



## DISEGNO TECNICO/TECHNICAL DRAWING

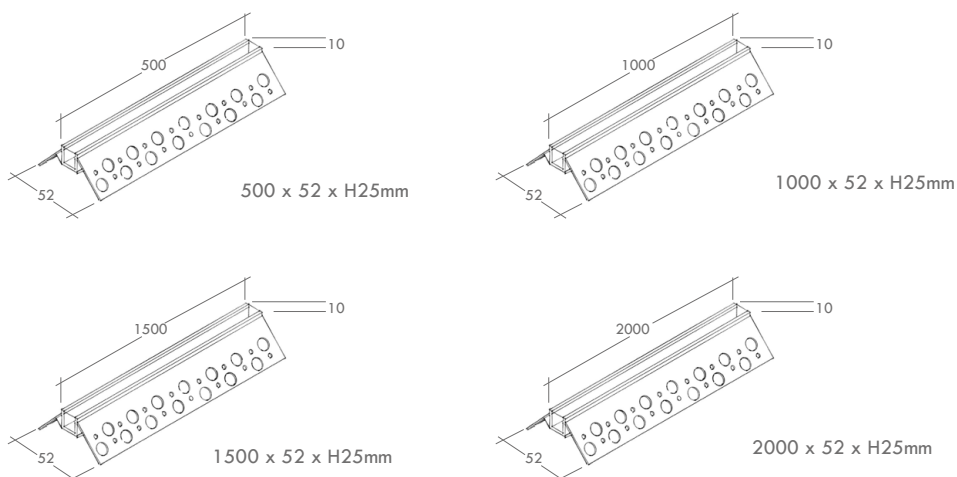

nome/name	misure/dimension	codice/code	sorgente/lamp	lumen/lumens		
				2700K	3000K	4000K
A3-65	500	04.104559	LED 7,2W	509	535	557
A3-65	1000	04.104560	LED 14,4W	1017	1070	1114
A3-65	1500	04.104561	LED 21,6W	1526	1605	1671
A3-65	2000	04.104562	LED 28,8W	2034	2140	2228

## ACCESSORI/ACCESSORIES

### codice/code



## ESEMPIO COMPOSIZIONE CODICE/ EXAMPLE OF CODE COMPOSITION

04.104559.03.DI.BP.P

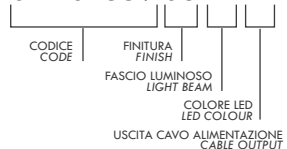

### Fascio luminoso / Light beam

.DI schermo opale fascio 155° /  
opal diffuser beam 155°

### Colore LED / LED Colour

codice/ code	Colore LED / LED Colour	potenza/m / power/m	lumen/m / lumes/m
.BC	2700K	14,4W	1017
.BP	3000K	14,4W	1070
.BF	4000K	14,4W	1114

## FINITURA/FINISH

### colore/colour codice/code

.03 / alluminio anodizzato  
anodized aluminium



# A3 - E



## DISEGNO TECNICO/TECHNICAL DRAWING

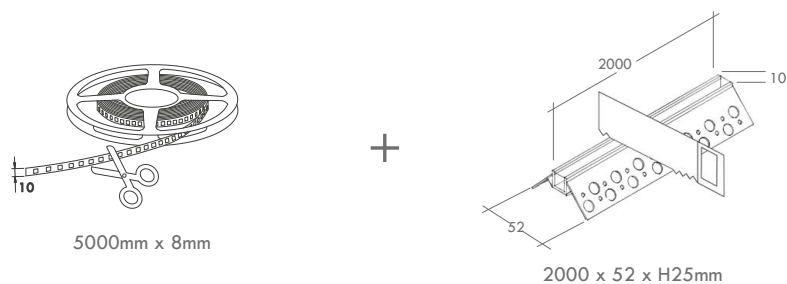

nome/name	misure/dimension	codice/code	grado IP	sorgente/lamp	lumen/lumens		
					2700K	3000K	4000K
CIRCUITO LED IN BOBINE/ LED CIRCUIT REEL	5000	30.104543	IP20	14,4 W/m	1017	1070	1114
A3 - E	2000	30.104564	IP40				

## ACCESSORI/ACCESSORIES

### codice/code



## ESEMPIO COMPOSIZIONE CODICE CIRCUITO LED/ EXAMPLE OF CODE COMPOSITION LED CIRCUIT

30.104543.DP.BP.20

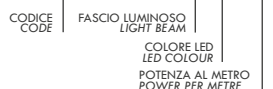

### Fascio luminoso/Light beam

Led	Colore/Colour	lm/m	Led/m	Taglio/Cut
.DP	diffuso perpendicolare/perpendicular diffused			
.BC	2700K	1017	350	20mm
.BP	3000K	1070	350	20mm
.BF	4000K	1114	350	20mm
<b>Potenza circuito Led/Led circuit power</b>				
.15	14,4W/m			

## FINITURA/FINISH

### colore/colour codice/code



# LETTURA DEL CATALOGO READING THE CATALOGUE

NOME FAMIGLIA  
SERIES NAME

## FLAT EVO

DESIGN: R&D

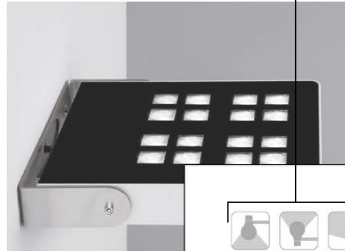

Apparecchio realizzato in lega di alluminio Anticorrodal, per l'impiego continuo in ambito esterno, pensato per l'installazione a pavimento, parete e soffitto per mezzo di staffa orientabile in acciaio inox dotata di scala graduata e blocco meccanico del puntamento. Finalizzato all'impiego di sorgenti LED di alta potenza ha corpo sottoposto a trattamento di anodizzazione fino a 18 micron e verniciato a polveri di poliestere per garantire l'inalterabilità nel tempo e la massima resistenza agli attacchi di agenti atmosferici. Completa la struttura uno specifico schermo in vetro extrachiaro serigrafato e temprato, saldate al corpo mediante apposito collante sigillante di derivazione navale. Il grado di protezione dell'apparecchio IP66 è garantito dalla presenza di apposito sistema pressocavo stagno inserito nell'apparecchio. Ottiche di precisione in PMMA, consentono la propagazione del fascio luminoso a grandi distanze. La presenza di driver integrato ad ogni apparecchio permette la loro alimentazione a 230VAC. Dotato di 50cm di cavo in neoprene per il collegamento alla linea di alimentazione mediante appositi sistemi di giunzione da ordinare separatamente.

Luminaire made of anticorrodal alloy in outdoors area. It is designed for through stainless steel adjustable bracket and mechanical locking system, its body is submitted to anodization and polyester powder coated to get maximum resistance against atmospheric agents. Completing the structure through a special glue-sealant precision optics allow the propagation of light beam to great distances. The protection degree IP66 is ensured by the presence of a special gasket system inserted in the luminaire's body. It is equipped with an electronic driver integrated in the luminaire's body. The supply at 230VAC. It is equipped with a 50cm cable in neoprene for connection to the supply line, connection systems to be ordered separately.

TIPI DI EMISSIONE LUMINOSA  
TYPE OF LIGHT EMISSION

CONFIGURAZIONI DISPONIBILI  
AVAILABLE CONFIGURATIONS

MARCHI E REQUISITI  
MARKING AND REQUIREMENTS



45 x 77 x H40mm

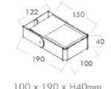

100 x 190 x H40mm

### FLAT EVO 1

codice/code	ottica/optic	sorgente/lamp	lumen/lumens
			3000K 4000K
03.104050	.SP .MD .FL .RD	LED 1x2,2W	214 288

### FLAT EVO 2

codice/code	ottica/optic	sorgente/lamp	lumen/lumens
			3000K 4000K
03.104051	.SP .MD .FL .RD	LED 4x2,2W	1020 1105

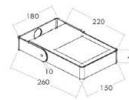

150 x 260 x H40mm

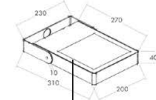

200 x 310 x H40mm

### FLAT EVO 3

codice/code	ottica/optic	sorgente/lamp	lumen/lumens
			3000K 4000K
03.104052	.SP .MD .FL .RD	LED 8x2,2W	2040 2205
	.AS	LED 17,5W	2809 2896

### FLAT EVO 4

codice/code	ottica/optic	sorgente/lamp	lumen/lumens
			3000K 4000K
03.104053	.SP .MD .FL .RD	LED 16x2,2W	3885 4205
	.AS	LED 25,7W	3810 3928

### ESEMPIO COMPOSIZIONE CODICE / EXAMPLE OF CODE COMPOSITION

Alimentatore elettronico 220/240V 50-60Hz integrato nel corpo dell'apparecchio.

Electronic driver 220/240V 50-60Hz integrated in the luminaire's body.

03.104050.01.AS.BF



### Fascio luminoso/Light beam

- .SP fascio/beam 10°-15°
- .MD fascio/beam 20-35°
- .FL fascio/beam 40-55°
- .RD road
- .VE vertical elliptical 8°x48°
- .HE horizontal elliptical 48°x8°

### Colore LED/LED Colour

- .SP 3000K
- .BF 4000K

### FINITURA/FINISH

colore/colour	codice/code	colore/colour	codice/code	colore/colour	codice/code
[White]	.01 / verniciato bianco painted white	[Black]	.02 / verniciato nero painted black	[Anodized]	.03 / alluminio anodizzato anodized aluminium
[Brown]	.04 / verniciato cor-ten painted cor-ten	[Grey]	.11 / verniciato antracite painted antracite		

### DESCRIZIONE TECNICA DELL'APPARECCHIO LUMINAIRE TECHNICAL DESCRIPTION

- .08/cemento
- .06/alluminio lucido o inox lucido
- .05/alluminio satinato o inox satinato
- .04/verniciato cor-ten
- .03 verniciato grigio (RAL 9006) o alluminio anodizzato
- .02/verniciato nero (RAL 9005) o anodizzato nero
- .01/verniciato bianco (RAL 9016)
- .00/naturale
- .08/concrete
- .06/polished aluminium or polished stainless
- .05/satin aluminium or satin stainless
- .04/painted cor-ten
- .03/painted grey (RAL 9006) or anodized aluminium
- .02/painted black (RAL 9005) or black anodized
- .01/painted white (RAL 9016)
- .00/natural

FINITURE DISPONIBILI  
AVAILABLE FINISHES

TABELLA COMPOSIZIONE CODICE  
CODE COMPOSITION TABLE

### DESCRIZIONE SORGENTE LAMP DESCRIPTION















CODICE RADICE APPARECCHIO  
LUMINAIRE CODE

OTTICHE  
OPTICS

### DISEGNO TECNICO TECHNICAL DRAWING

# SIMBOLOGIA SYMBOLS

## Configurazioni disponibili/Available configurations

	Apparecchio disponibile in versione RGB (solo per versioni con min. 3 lampade o versioni LED).	Luminaire available in RGB version (only for versions with a min. of 3 lamps or LED versions).
	Apparecchio disponibile in versione CTC (controllo temperatura di colore, solo per versioni con min. 3 lampade o versioni LED).	Luminaire available in CTC version (colour temperature control, only for versions with a min. of 3 lamps or LED versions).
	Apparecchio con possibilità di dimmerazione.	Luminaire has possibility to be dimmed.
	Apparecchio con possibilità di dimmerazione 0/10.	Luminaire has possibility to be dimmed 0/10.
	Apparecchio con possibilità di dimmerazione DALI.	Luminaire has possibility to be dimmed DALI.
	Apparecchio con possibilità di dimmerazione PWM.	Luminaire has possibility to be dimmed PWM.
	Apparecchio disponibile con apparato di diffusione sonora ad induzione.	Luminaire available with induction sound diffusion system.
	Apparecchio disponibile con Router Wi-Fi interno per la diffusione nello spazio circostante di segnali wire-less di ogni genere.	Luminaire available with internal Wi-Fi Router for the diffusion of any kind of wireless signal in the surrounding space.
	Kit emergenza	Emergency Kit
	Apparecchio personalizzabile (con fattibilità da verificare). Modifiche su richiesta: -finitura RAL -dimensione -tecnologia di comunicazione (DALI, WIFI o AUDIO integrato)	Luminaire customizable (with feasibility to be checked). Changes on request: -RAL finish -size -communication technology (integrated DALI, WIFI or AUDIO)
	Apparecchio disponibile a richiesta in versione RGB (solo per versioni con sorgente LED o con minimo 3 lampade).	Luminaire available, on request, in RGB version (only for LED versions or with a minimum of 3 lamps).
	Apparecchio disponibile a richiesta in versione CTC (controllo temperatura di colore, solo per versioni con min. 3 lampade o versioni LED).	Luminaire available, on request, in CTC version (colour temperature control, only for versions with a min. of 3 lamps or LED versions).
	Apparecchio disponibile su richiesta in versione dimmerabile.	Luminaire available, on request, in dimmable version.
	Apparecchio disponibile, su richiesta, con schermo microprismatizzato per elevato comfort visivo.	Luminaire available, on request, with microprismatic screen for high visual comfort.
	Protezione Acqua Stop	Water Stop protection

## Protezioni IP/IP Protection degree code

### 1° CIFRA - Protezione da corpi solidi/

IP1...	Protezione da corpi solidi $\geq 50\text{mm}$
IP2...	Protezione da corpi solidi $\geq 12\text{mm}$
IP3...	Protezione da corpi solidi $\geq 2,5\text{mm}$
IP4...	Protezione da corpi solidi $\geq 1\text{mm}$
IP5...	Protezione da polvere
IP6...	Protezione totale da polvere

### 1st DIGIT - Protection against solid bodies

IP1...	Protection against solid bodies $\geq 50\text{mm}$
IP2...	Protection against solid bodies $\geq 12\text{mm}$
IP3...	Protection against solid bodies $\geq 2,5\text{mm}$
IP4...	Protection against solid bodies $\geq 1\text{mm}$
IP5...	Protection against dust
IP6...	Total protection against dust

### 2° CIFRA - Protezione da acqua

IP..1	Protezione da caduta di gocce verticali
IP..2	Protezione da caduta di gocce con inclinazione di $15^\circ$
IP..3	Protezione da spruzzi d'acqua con inclinazione di $60^\circ$ dall'alto
IP..4	Protezione dagli spruzzi d'acqua da ogni direzione
IP..5	Protezione dai getti d'acqua
IP..6	Protezione da inondazioni
IP..7	Protezione contro l'immersione temporanea fino a $30'$ sotto $1\text{m}$ d'acqua
IP..8	Protezione contro l'immersione continua sotto $1\text{m}$ d'acqua















### 2nd DIGIT - Protection against water

IP..1	Protection against vertically falling drops
IP..2	Protection against vertically falling drops with a tilt angle up to $15^\circ$
IP..3	Protection against sprays of water up to $60^\circ$ from devertical
IP..4	Protection against water spray from all directions
IP..5	Protection against water jets
IP..6	Protection against powerful water jets
IP..7	Protection against temporary immersion up to $30'$ under $1\text{m}$ of water
IP..8	Protection against continuous immersion under $1\text{m}$ of water

## Tipologia di alimentazione/Power supply type



## Marchi e requisiti/Certificates and requirements

	Apparecchio in classe prima con isolamento elettrico fondamentale. Deve essere collegato al circuito di terra dell'impianto elettrico generale.	Class I Luminaire with basic electrical insulation. It must be connected to the earth circuit of the general electrical system.
	Apparecchio in classe seconda con doppio isolamento elettrico. Non necessita di collegamento al circuito di terra dell'impianto elettrico.	Class II luminaire with double electrical insulation. There is no need for connection to the earth circuit of the electrical system.
	Apparecchio in classe terza predisposto per il collegamento a circuiti a bassissima tensione.	Class III luminaire suitable for connection to extra-low voltage circuits.
	Marchatura CE	CE Marking
	L'apparecchio può essere installato su superfici normalmente infiammabili.	The luminaire can be installed on normally flammable surfaces.
		
	ISO 9001	
	Ellissi di Macadam.	Macadam Ellipse.
	Resistenza al carico statico.	Static load resistance.
	Lunghezza del cavo di alimentazione in dotazione.	Length of supplied power cable.
	Uscita cavo di alimentazione L= Laterale P= Posteriore T= Testa	Cable Output L= Side P= Rear T= Head
	Protezione contro sbalzi di tensione	Protection against sudden changes in voltage.
	Protezione contro l'inversione di polarità	Reverse polarity protection.
	Rotazione dell'apparecchio sull'asse verticale.	Luminaire rotation on vertical axis.
	Inclinazione dell'apparecchio sull'asse orizzontale.	Luminaire inclination on horizontal axis.
	Tipo di emissione luminosa.	Type of light emission.

## Resistenza agli urti/Shock resistance

	IK00 Non protetto/ No protection	IK03 0,35 J	IK07 2,00 J
	IK01 0,15 J	IK04 0,50 J	IK08 5,00 J
	IK02 0,20 J	IK05 0,70 J	IK09 10,00 J
		IK06 1,00 J	IK10 20,00 J

## Condizioni generali/General Conditions

Le potenze ed i flussi luminosi indicati nel presente catalogo sono riferiti alle sorgenti LED.

Wattage and lumens indicated in this catalogue are referred to the LED sources.

Lam32 srl si riserva il diritto di apportare modifiche ai prodotti della collezione al fine di miglioramento o per esigenza di carattere tecnico e commerciale. Vi invitiamo a consultare il sito [www.lam32.com](http://www.lam32.com) per avere i dati continuamente aggiornati.

Lam32 Ltd reserves the right to make every changes to the products of the this collection, to improve the betterment, or to meet the technical and commercial needs. We invite you to visit the website [www.lam32.com](http://www.lam32.com), as to have always the data updated.