

Bring the lines to the
forefront: now you
can do more

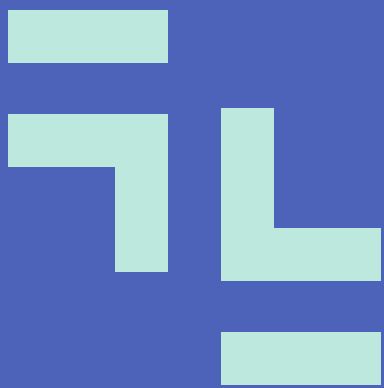

TRACELINE

Reggiani

Reggiani

Traceline

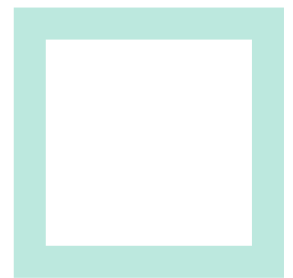
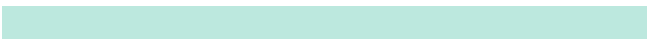



Traceline System	10
-------------------------	-----------

Optical solutions	16
--------------------------	-----------

LED	20
------------	-----------

Controls	22
-----------------	-----------

Traceline Recessed	24
--------------------	----

Traceline Surface/Pendant	28
---------------------------	----

Traceline Pendant Direct/Indirect	32
-----------------------------------	----

Angles and squares	36
---------------------------	-----------

Continuous line	42
------------------------	-----------

Yori Modules	44
---------------------	-----------

Fade	48
-------------	-----------

Finishes	50
-----------------	-----------

Codes	54
--------------	-----------



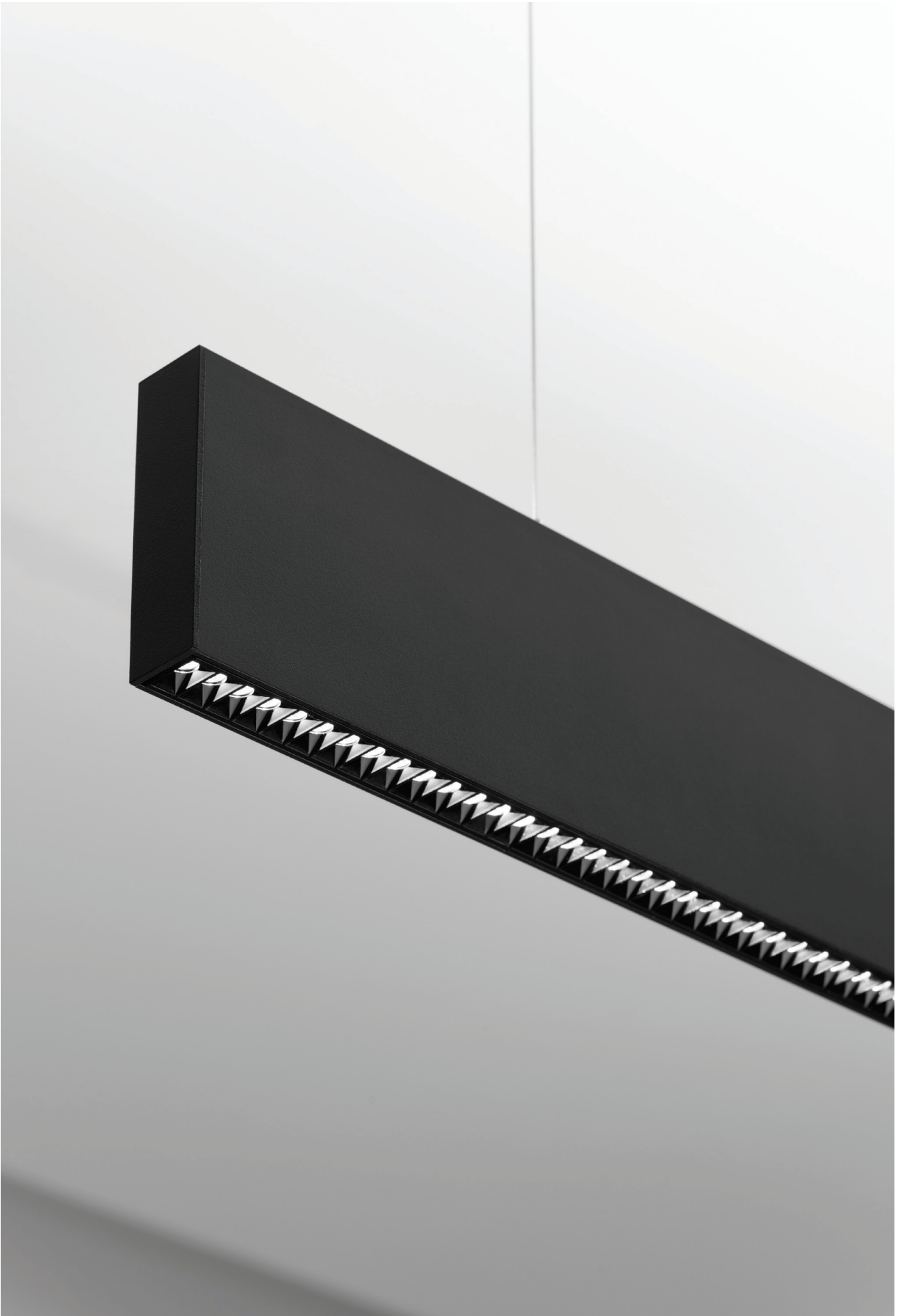

Traceline

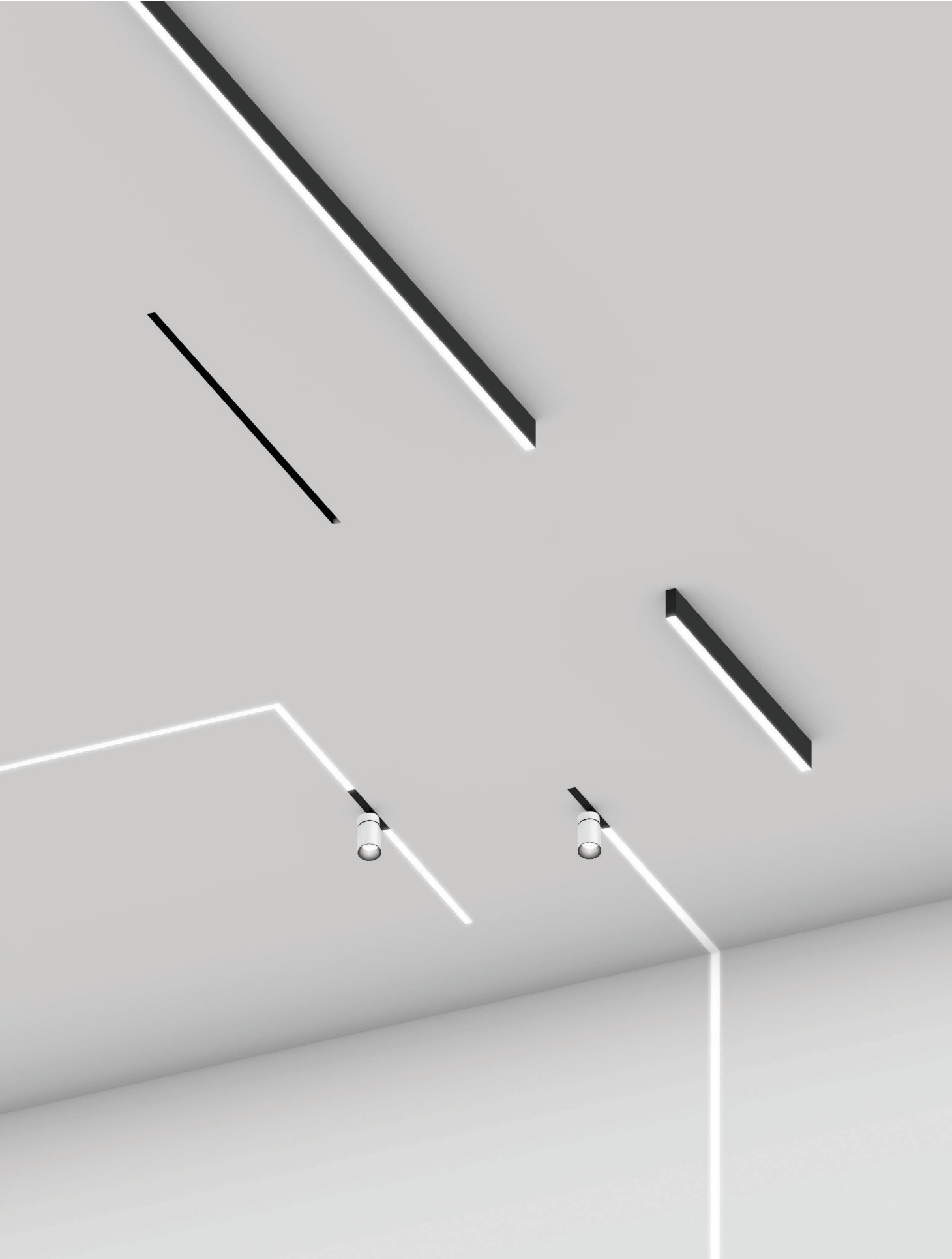







EN Traceline has reinvented linear lighting by using the latest technology to deliver the most flexible system ever created. Traceline can be Deep Recessed, Recessed, Surface, Pendant or Deep Pendant mounted with the ability also to insert Yori spotlights. Built-in wireless controls and a variety of finishes and optical options.

IT Traceline ha reinventato l'illuminazione lineare utilizzando le più avanzate tecnologie per offrire il sistema di illuminazione lineare più flessibile mai creato. Traceline è un sistema di illuminazione lineare disponibile nella versione Deep Recessed, Recessed, Surface, Pendant e Deep Pendant - con la possibilità di inserire proiettori Yori. Il sistema offre controlli wireless integrati e una varietà di finiture e opzioni ottiche.

10

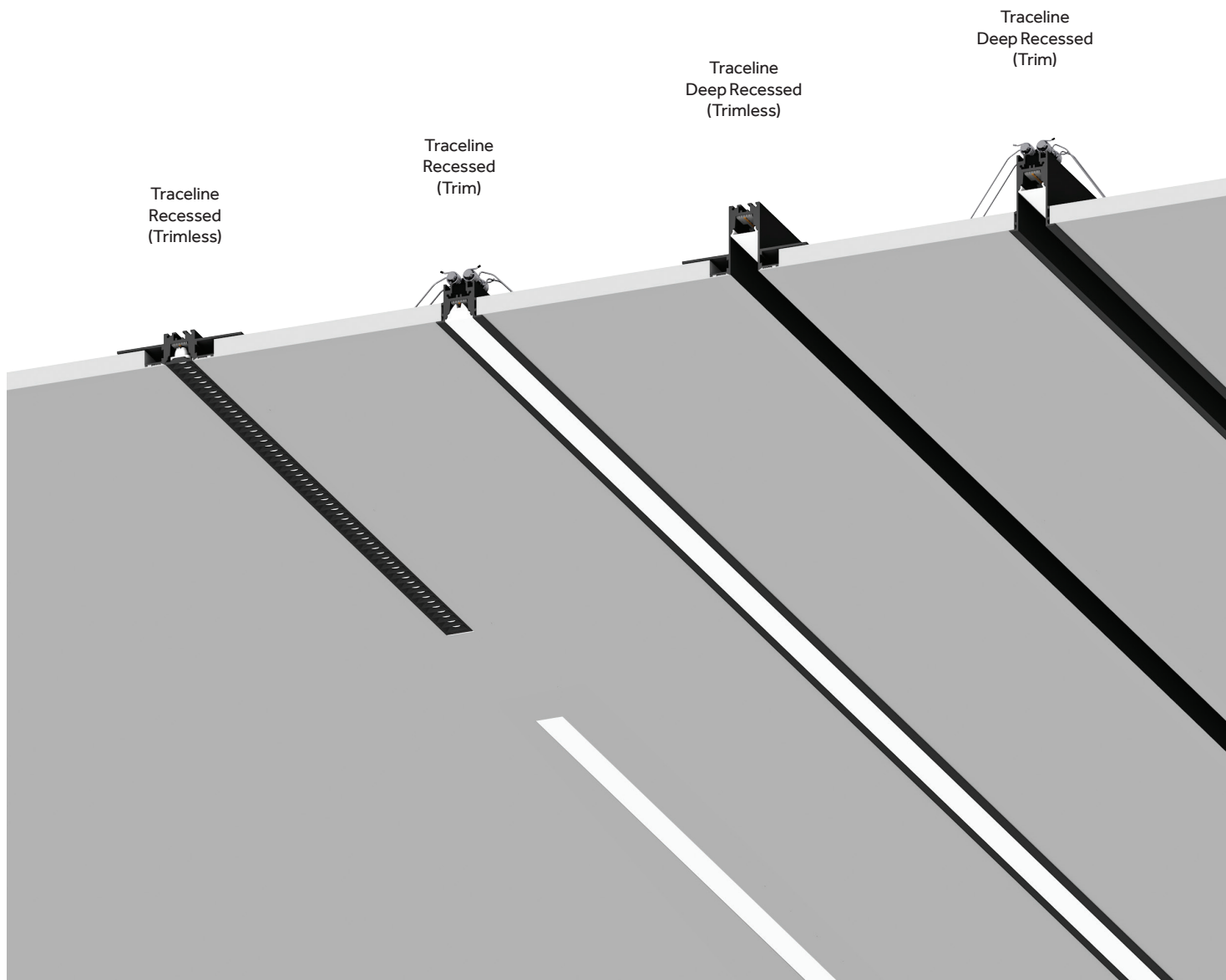

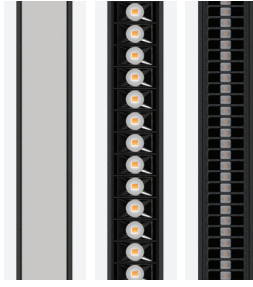

Optical solutions
p.16



Angles and squares
p.36



Traceline Yori Modules
p.44

Traceline
Surface/Pendant

Traceline
Pendant
Direct/Indirect

Traceline
Deep Pendant
Direct/Indirect

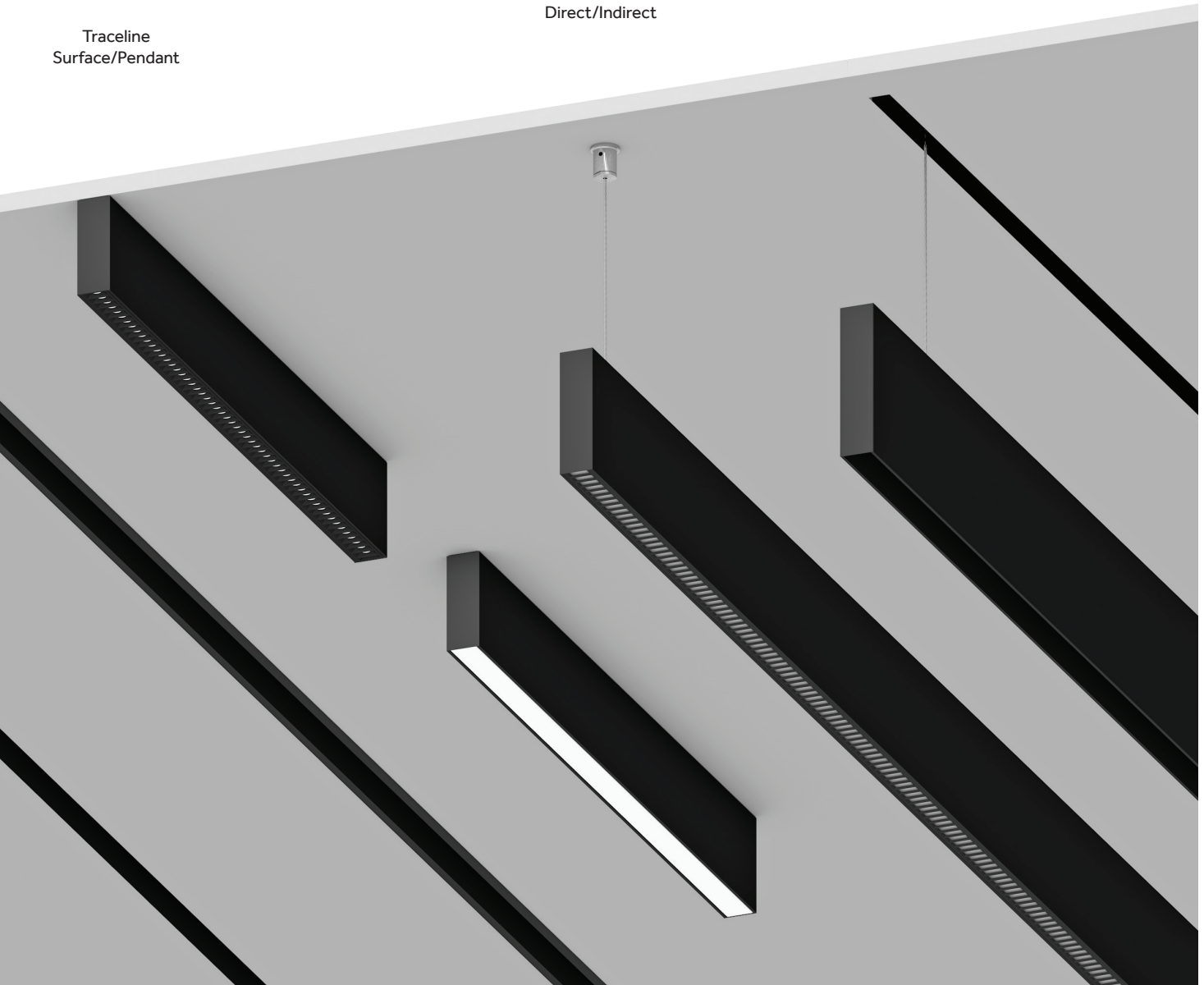

Choose an application:

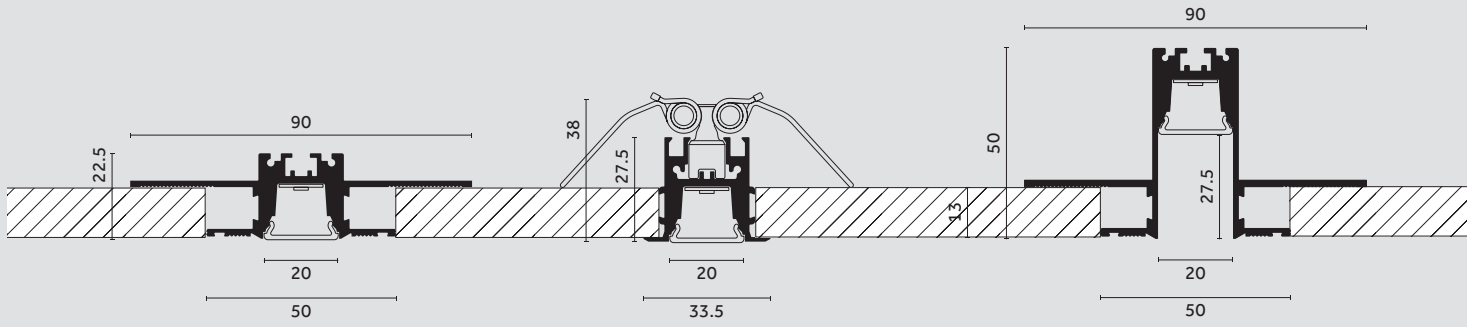

Traceline Recessed (Trimless)
p.24

Traceline Recessed (Trim)
p.24

Traceline Deep Recessed (Trimless)
p.24

Choose a length:

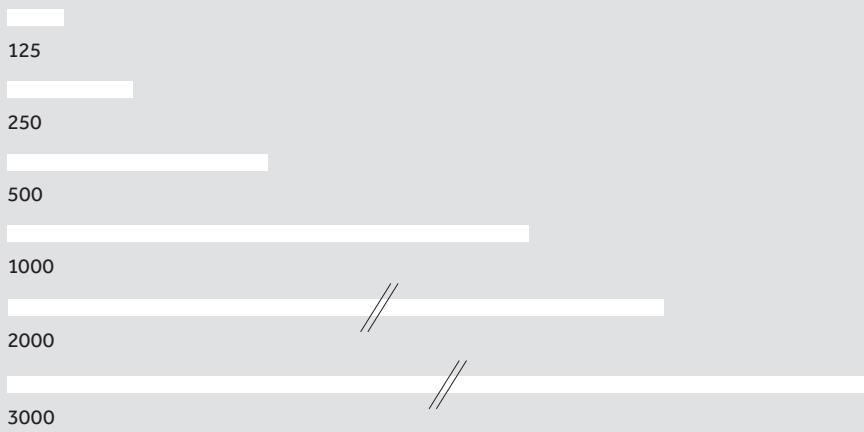

Optical solutions:

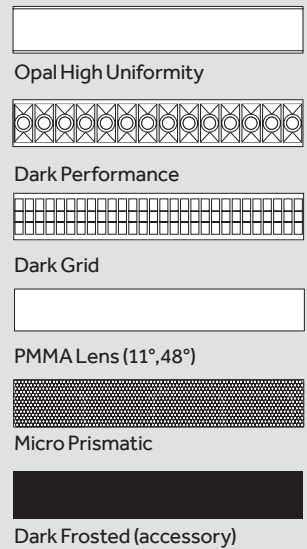

p.16

Do you need a lighting angle or a square?

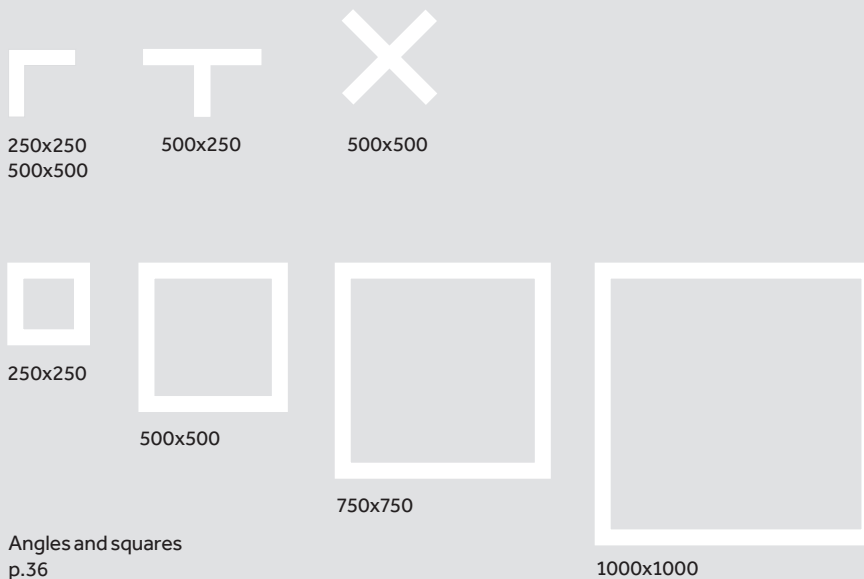

Angles and squares
p.36

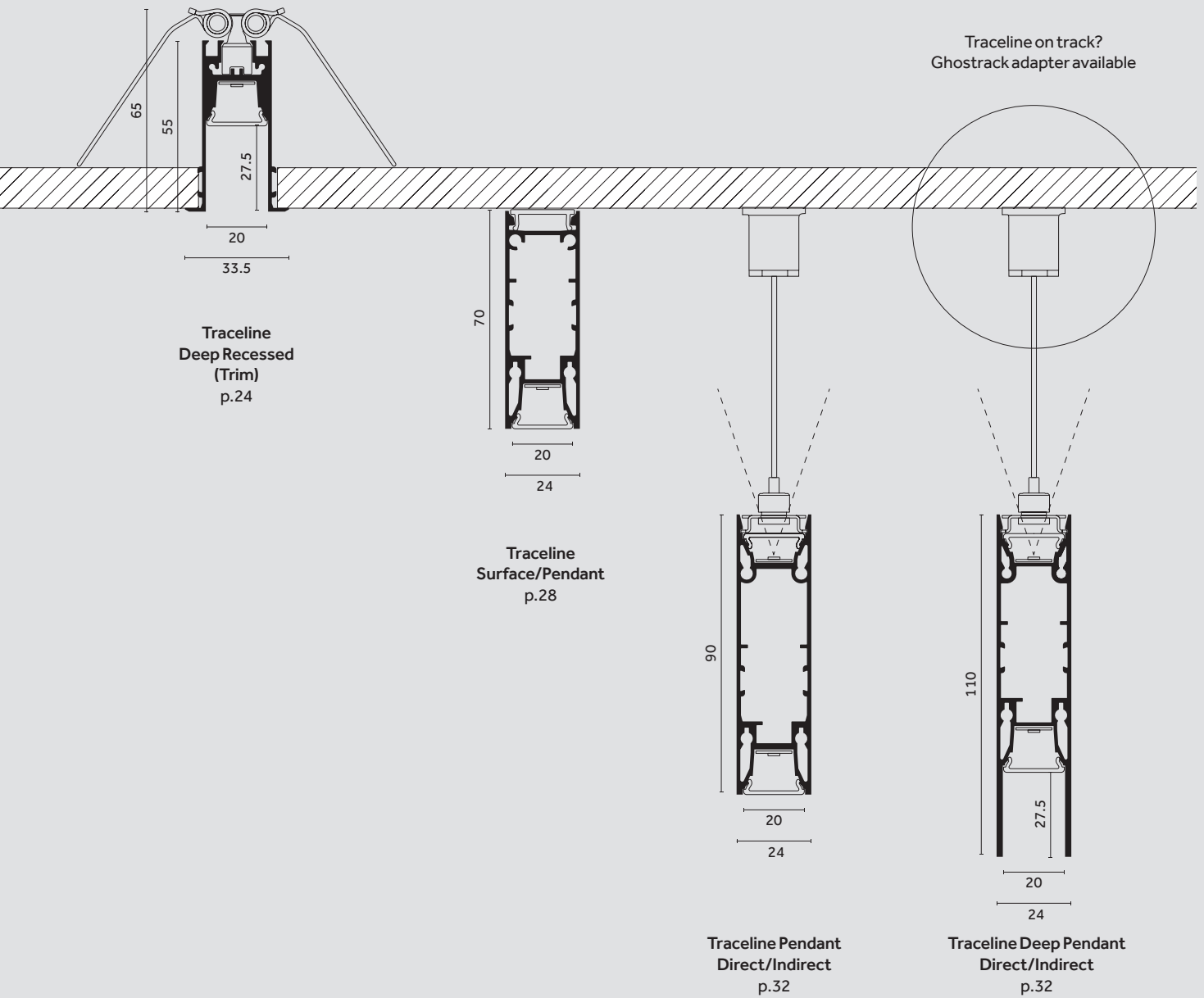

Do you want to add a Spotlight?

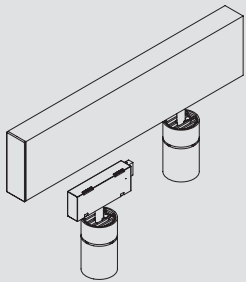

Yori Modules p.44

Complete your lighting scheme:

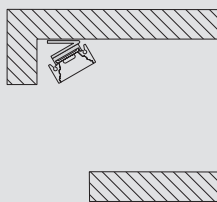

Fade p.48

Light in your hands:



Controls p.22

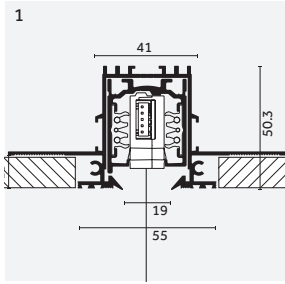

EN Ghostrack adapter
IT Adattatore Ghostrack

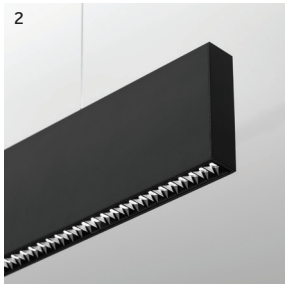

EN Diffuser: Dark Performance
IT Diffusore: Dark Performance

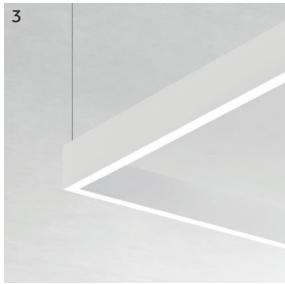

EN Traceline Pendant - Square
IT Traceline Pendant - Square



EN Traceline Surface with wall
mounting accessory
IT Traceline Surface con
accessorio montaggio a parete.

14

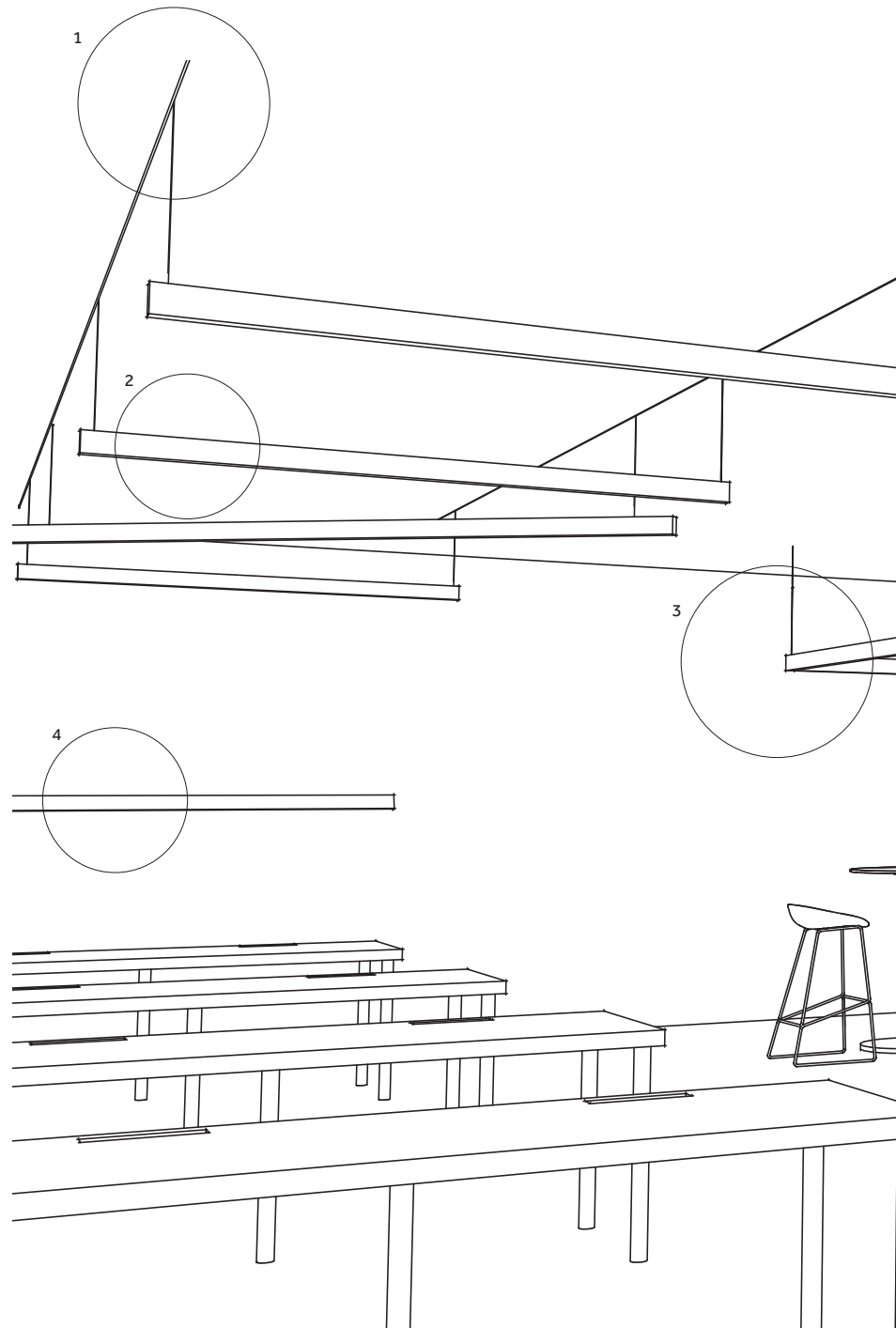

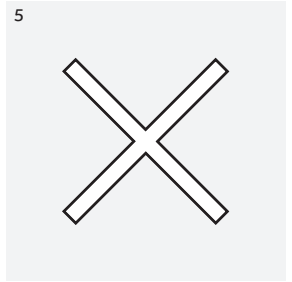
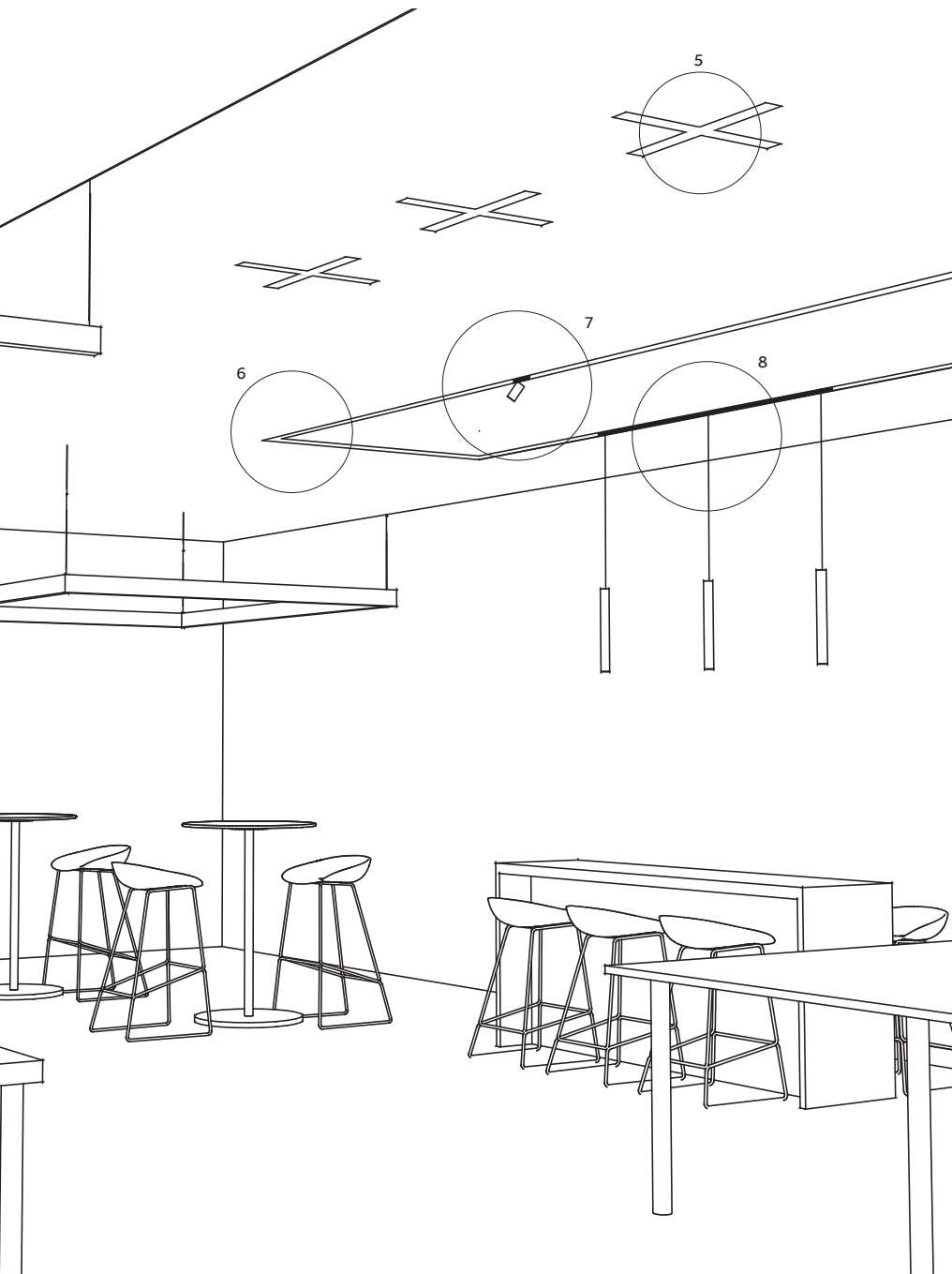

EN Traceline Recessed "X"
IT Traceline Recessed "X"

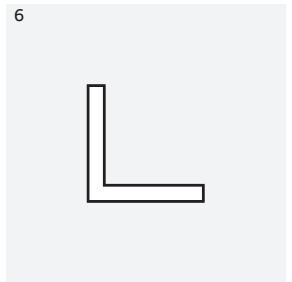

EN Traceline Recessed "L"
IT Traceline Recessed "L"



EN Traceline Yori module
IT Traceline Yori module



EN Traceline Yori module
IT Traceline Yori module

Optical solutions

EN Traceline is available with six different optical options to offer solutions for multiple application areas: Opal with different transmittance indexes and Black Opal (accessory) for soft and diffuse lighting; Micro Prismatic, for greater visual comfort and high efficiency; Dark Performance UGR<16 and Dark Grid UGR<14, to reduce the glare index; 48° and 11° extruded lens in PMMA with high performance for general or grazing lighting.

IT Traceline è disponibile con sei differenti opzioni ottiche per molteplici ambiti di applicazione: Opale con differenti indici di trasmittanza e Opale nero (accessorio) per un'illuminazione soft e diffusa; Micro Prismatico, per maggiore comfort visivo ed elevata efficienza; Dark Performance UGR <16 e Dark Grid UGR <14, per ridurre l'indice di abbagliamento; Lente estrusa 48° e 11° in PMMA dalle alte performance per l'illuminazione generale diffusa o radente.

16

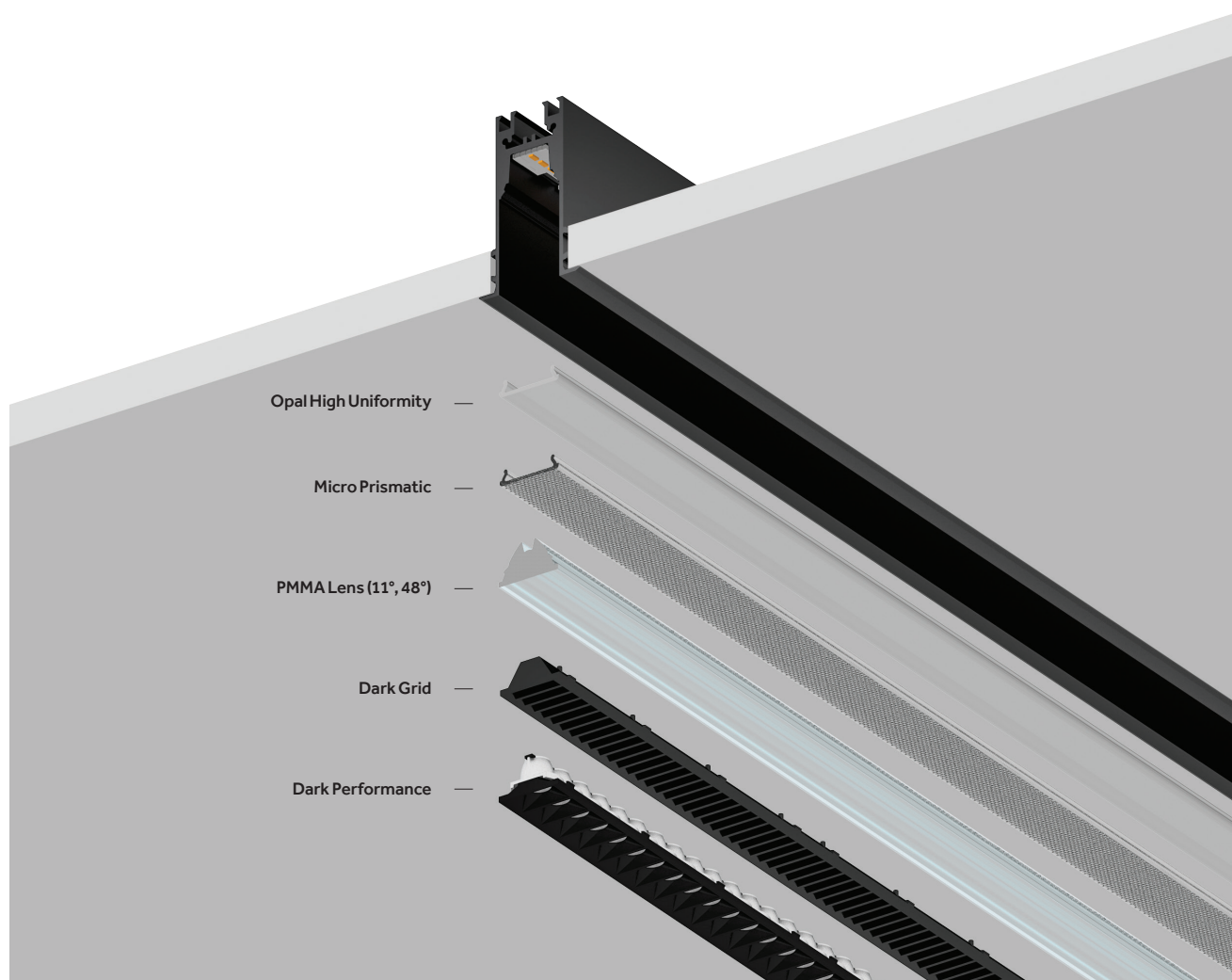

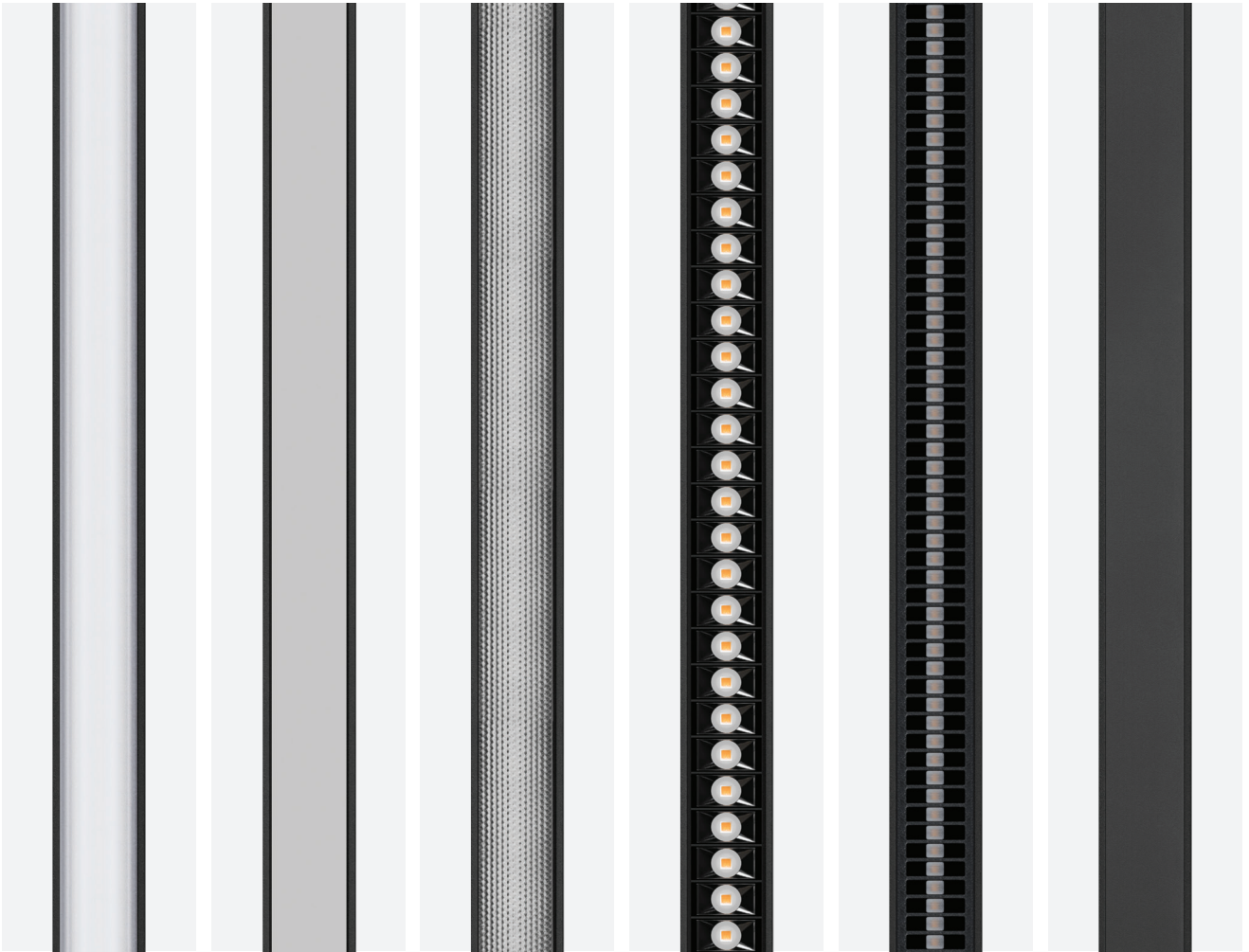

**PMMA Lens
(11°)**

**Opal High
Uniformity (110°)**

**Micro Prismatic
(70°/90°)**

**Dark Performance
(40°)**

**Dark Grid
(60°/20°)**

**Dark Frosted
(Accessory)**

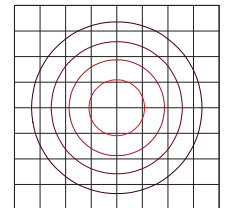
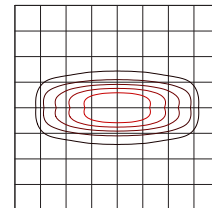
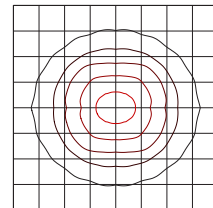
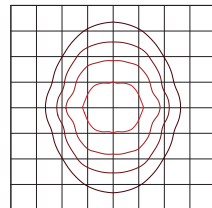
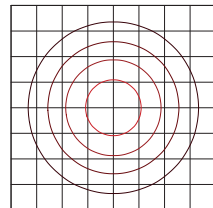
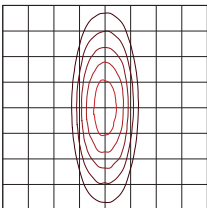

High Performance
Extruded PMMA

Direct Light
T 55%
Efficacy up to 88 Lm/W
Indirect Light
T 70%
Efficacy up to 96 Lm/W

Low Glare
Efficacy up to 73 Lm/W

UGR<16
Efficacy up to 70 Lm/W

UGR<14
Cross Oval

Matt Black finish

**PMMA Lens
(48°)**

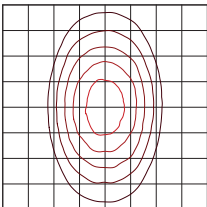

High Performance
Extruded PMMA



18

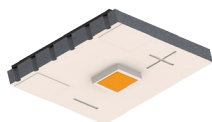

EN MID POWER LED with excellent performances and high colour rendering CRI>90 and CRI>95, less sensible to the quantitative reduction of phosphors on the diode, main cause of colour over angle.

IT MID POWER LED dalle prestazioni eccellenti e resa cromatica elevata CRI>90 e CRI>95, meno sensibili alla riduzione quantitativa dei fosfori sul diodo, causa principale del color over angle.



EN PMMA collimator micro lens with surface treatment for maximum colour homogeneity throughout all distribution width and for protection of the light source from dust and dirt.

IT Micro lente collimatrice in PMMA con trattamento superficiale per la massima omogeneità del colore per tutta l'ampiezza della distribuzione e per protezione della sorgente luminosa da polvere e sporcizia.

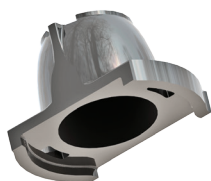

EN Reflector in metallic mirrored thermoplastic for high cut-off and reduction of the portion of uncontrolled direct light.

IT Riflettore in termoplastica metallizzata specchiata per elevato cut-off e riduzione della porzione di luce diretta non controllata

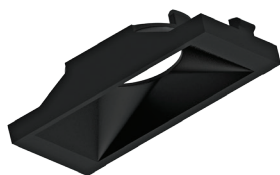

EN Glossy black plastic screen for glare reduction and lower UGR values.

IT Schermo in plastica nera lucida per riduzione dell'abbaglio e valori UGR più contenuti

Colour over angle



^{EN} Thanks to the newly developed optical solution, Dark Performance reflectors ensure a homogeneous illuminance without chromatic distortions on the whole width of the light distribution and a glare control with UGR values <16.

^{IT} Grazie alla soluzione ottica sviluppata, i riflettori Dark Performance assicurano un illuminamento omogeneo senza distorsioni cromatiche sull'intera ampiezza della distribuzione luminosa e un controllo dell'abbaglio con valori UGR<16

Dark Performance

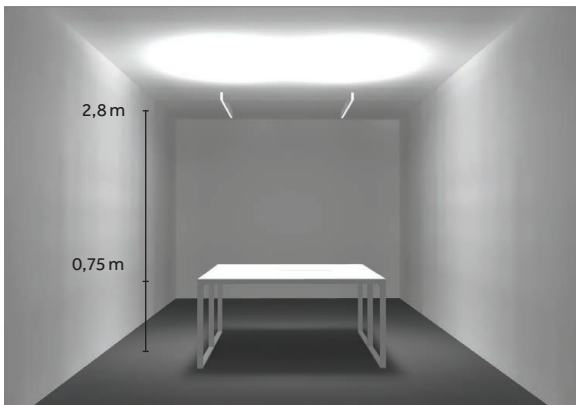

Product: Traceline Pendant Direct/Indirect
Product Length: 2 x 1000 mm
Diffuser: Dark Performance
LED: 3000 K
Power (Indirect light): 2 x 28 W
Power (Direct light): 2 x 21 W

Surface area 1,6 m x 1,6 m
Average illuminance >500 lx
Uniformity 0.58
Glare 65°, <240 cd/m²
UGR Trasversal <17
UGR Axial <17

Dark Grid

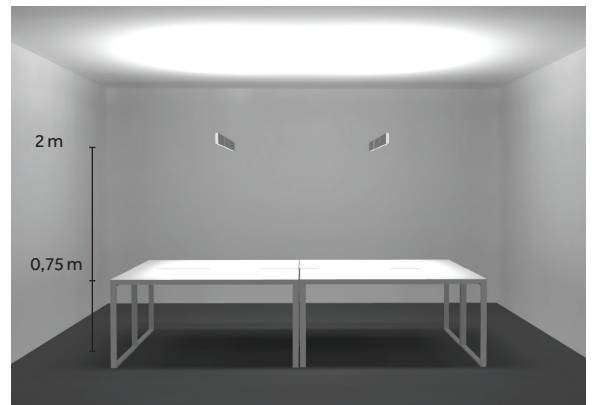

Product: Traceline Pendant Direct/Indirect
Product Length: 2 x 1500 mm
Diffuser: Dark Grid
LED: 3000 K
Power (Indirect light): 2 x 42 W
Power (Direct light): 2 x 42 W

Surface area 1,6 m x 3,2 m
Average illuminance >500 lx
Uniformity 0.5
Glare 65°, 35 cd/m²
UGR Trasversal <10
UGR Axial <10

LED

EN Traceline offers excellent performances thanks to the integration of latest generation light sources. The range includes Mid Power LEDs, with performance up to 170lm/w, High output and Mid output versions, options with high CRI > 95 and dynamic-white versions: Warm Dimming 1800-2700K and Tunable White 2200-6500K.

IT Traceline offre performance eccellenti grazie all'integrazione di sorgenti luminose di ultima generazione. La gamma proposta include LED Mid Power con performance fino a 170lm/w, versioni High output e Mid output, opzioni con CRI elevato >95 e versioni con bianco dinamico: Warm Dimming 1800-2700K e Tunable White 2200-6500K.

MID POWER LED

20

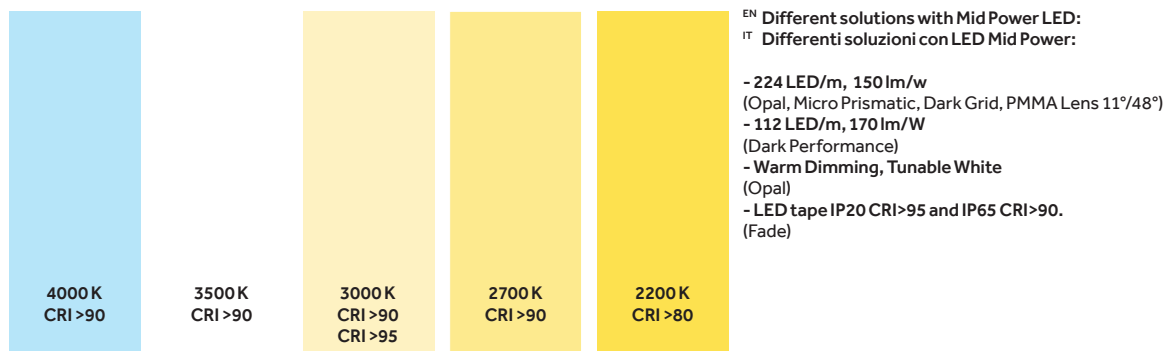

EN Wide range of LED temperatures:
- from 4000 K to 2200K with CRI>90 and 3000K options with CRI>95.
- Step Mc Adam < 3 and L80 B50: 50.000h
- Version with Opal diffuser (High output and Mid output) to meet different lighting needs.

IT Ampia gamma di temperature LED:
- da 4000 K a 2200K con CRI>90 e opzioni a 3000K con CRI>95.
- Step Mc Adam < 3 e L80 B50: 50.000h
- Versione con diffusore Opal (High output e Mid output) per rispondere ad esigenze di illuminamento differenti.



EN The Dark Performance optical version is available with HC LED (CRI > 95) - 3000K (on request for other CCTs). Thanks to an excellent color rendering and TM30 values of Rg = 90 and Rf = 100 it allows the use of Traceline also in commercial and residential applications where a very high CRI value is required.

IT La versione ottica Dark Performance è disponibile con LED HC (CRI > 95) - 3000K (a richiesta per altri CCT). Con un'eccellente resa cromatica e valori TM30 di Rg=90 e Rf=100 permette l'utilizzo di Traceline anche in applicazioni commerciali e residenziali dove viene richiesto un valore di CRI molto elevato.

Warm Dimming



2700 K

1800 K

EN Warm dimming: one channel control
IT Warm dimming: controllo a un canale

21

Tunable White

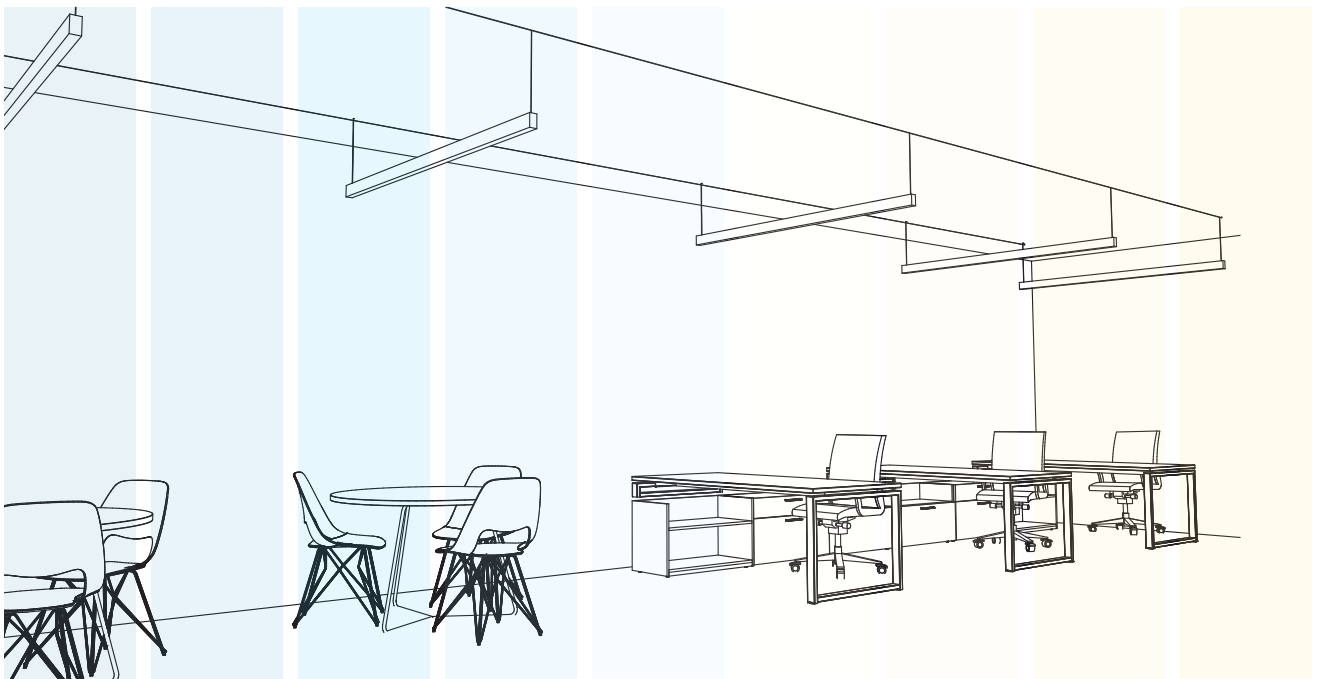

6500 K

2200 K

EN Tunable White: two channels control
IT Tunable White: controllo a due canali

Traceline

Light in your hands

^{EN} Traceline offers multiple control options, integrated or remote. The standard protocols available are: On/Off, DALI, Dimm 1-10 V (some versions available in Push Dimm) and Bluetooth. Traceline Surface, Pendant and Deep Pendant offer all control options integrated for both single and continuous applications and allow you to control standard CCTs or Dynamic white options (Warm Dimming or Tunable White).

^{IT} Traceline offre molteplici opzioni di controllo, integrate o remote. I protocolli standard disponibili sono: On/Off, DALI, Dimm 1-10 V (alcune versioni disponibili in Push Dimm) e Bluetooth. Traceline Surface, Pendant e Deep Pendant offrono tutte le opzioni di controllo integrate, sia per applicazione singola che in linea continua e permettono di controllare opzioni con CCT standard o con bianco dinamico (Warm Dimming o Tunable White).

22

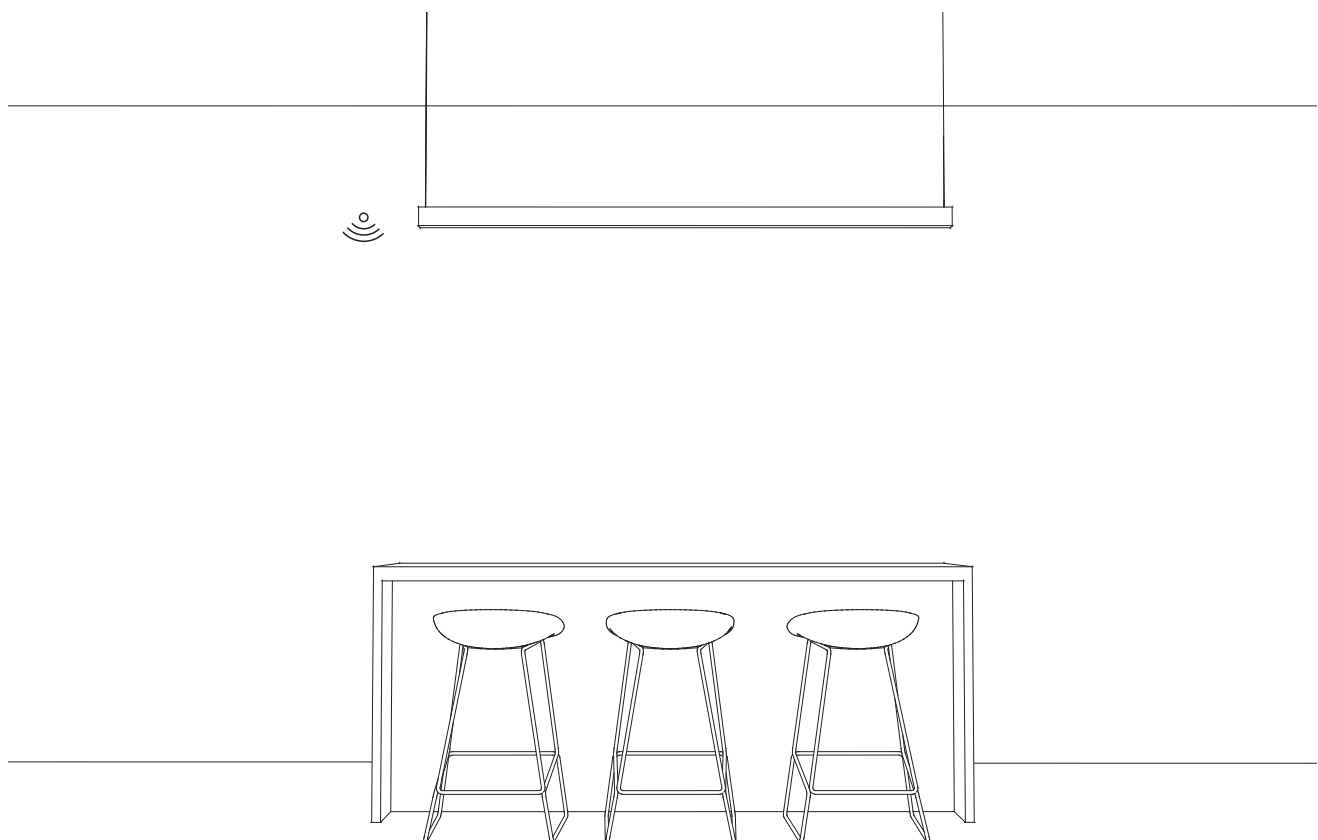

Controls

On/Off

DALI

Dimm 1-10 (Push Dimm)

Bluetooth

^{EN} Traceline Pendant - Single module

^{IT} Traceline Pendant - Modulo singolo

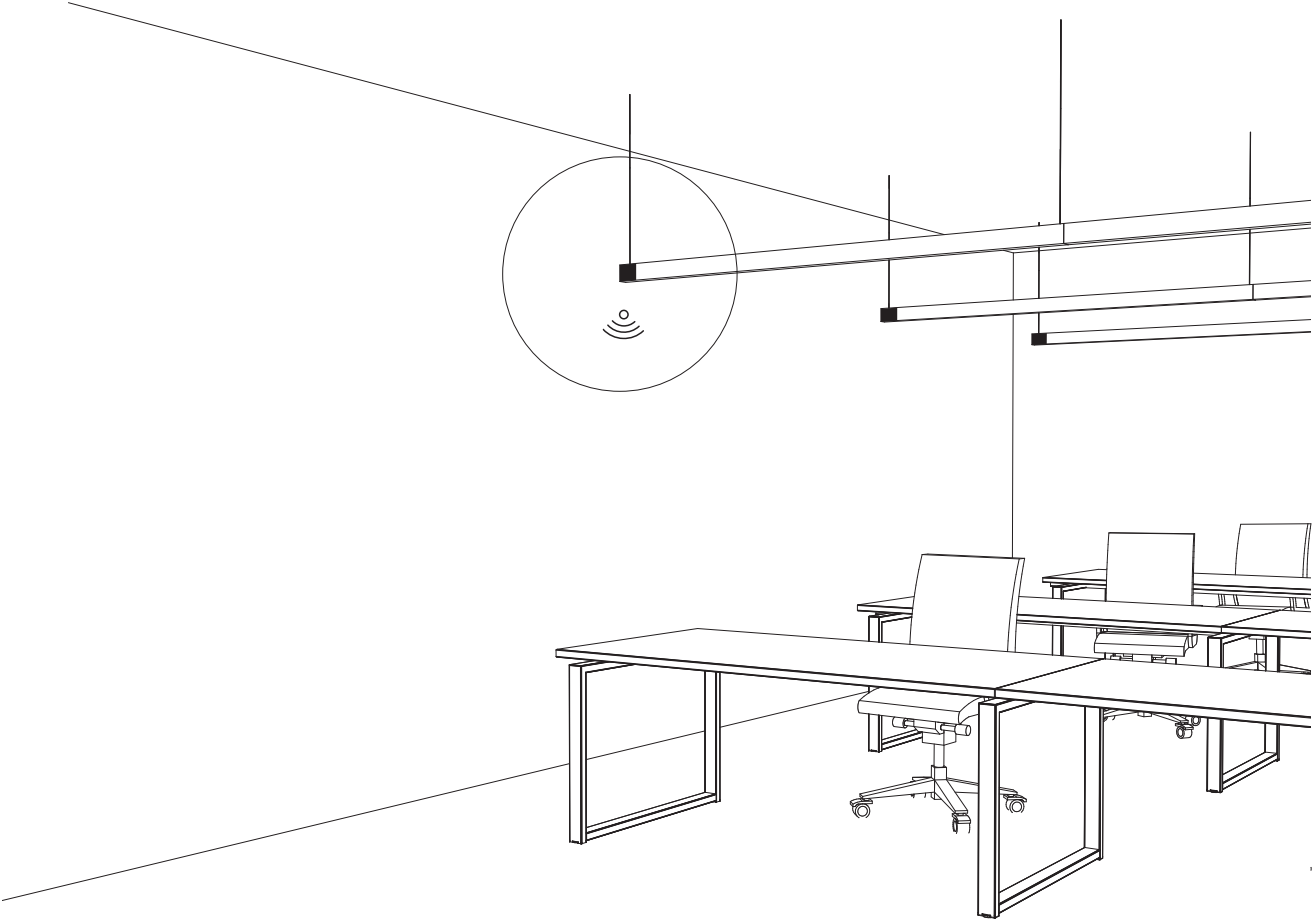

EN Through an App (available for iOS and Android systems), the Bluetooth system allows control of both single devices and continuous line configurations (available from October 2019).

IT Tramite un'App (disponibile per sistemi iOS e Android), il sistema Bluetooth consente il controllo sia di singoli apparecchi che di configurazioni in linea continua (disponibile da Ottobre 2019).

Traceline

Recessed

EN With its super narrow width of 20 mm, Traceline Recessed integrates perfectly into any kind of architecture and space. Invisible yet powerful, with an outstanding lumen output up to 90 lm/W. It is available also in the Deep Recessed version: the recessed LED makes the light even more discreet and offers an excellent visual comfort.

IT Con la sua dimensione estremamente ridotta di soli 20 mm, il nuovo Traceline Recessed si integra perfettamente in qualsiasi tipo di architettura e spazio. Invisibile ma potente, con un eccezionale lumen output fino a 90 lm/W. È disponibile anche nella versione Deep Recessed: il LED arretrato rende la luce ancora più discreta e offre un eccellente comfort visivo.

24

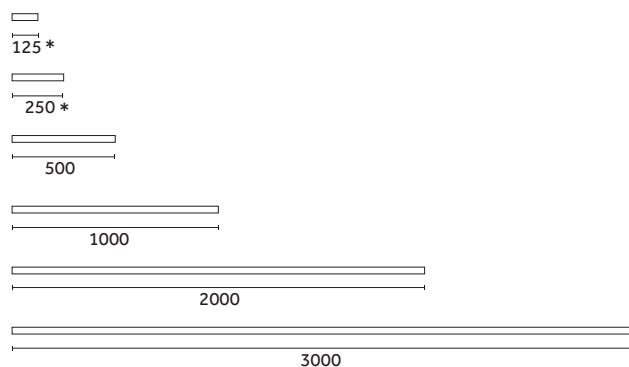

*Dark Performance and Recessed only

Optical solutions:



Control systems
p.22

Finishes
p.27

Yori Module
p.44

Shapes
p.36

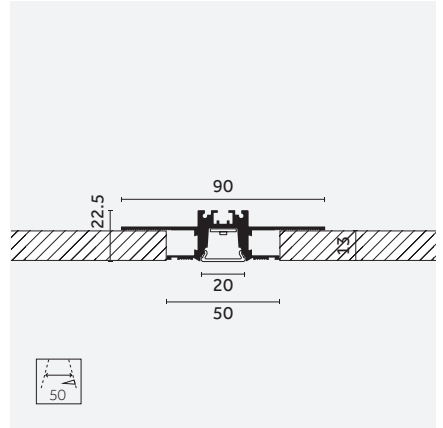
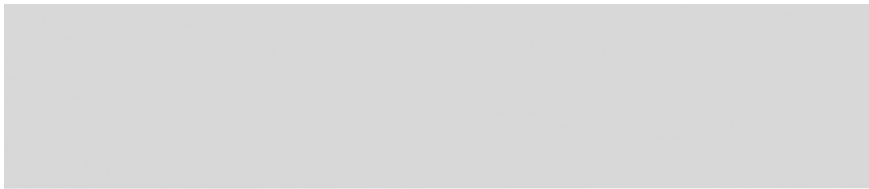

Traceline Recessed - Trimless

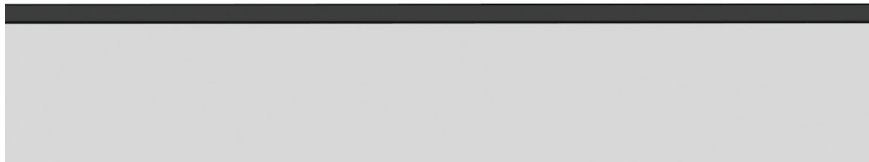
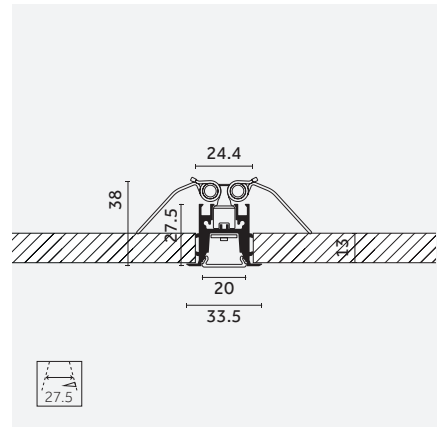

Traceline Recessed - Trim

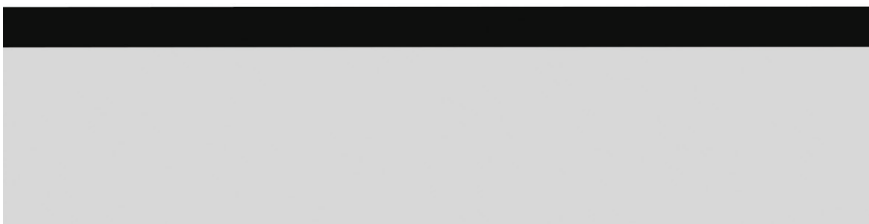
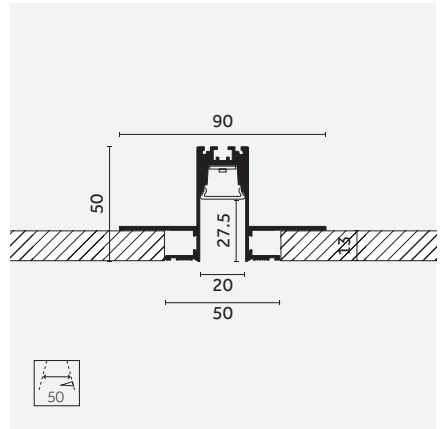
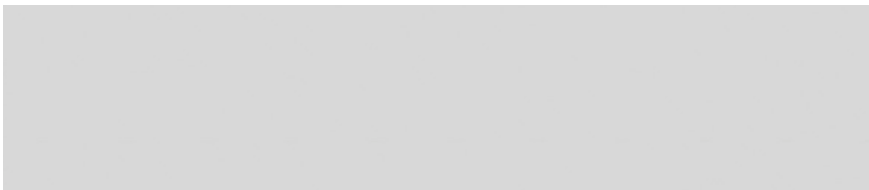

Traceline Deep Recessed - Trimless

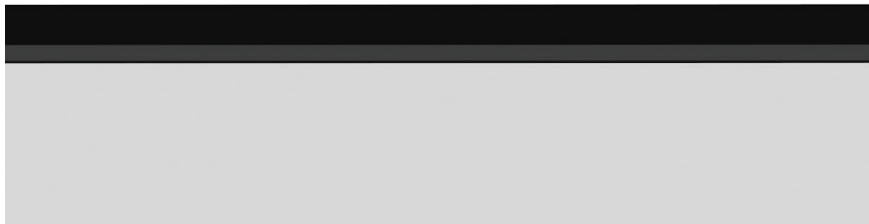
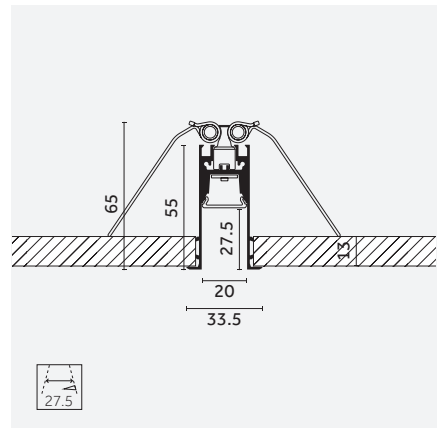
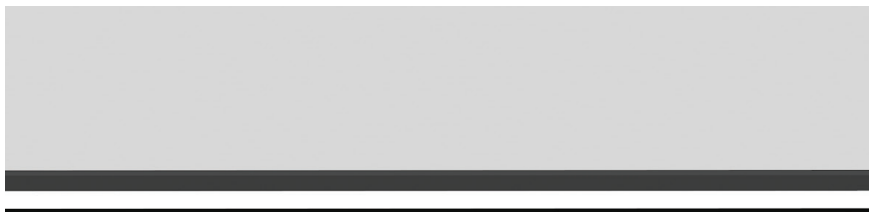

Traceline Deep Recessed - Trim

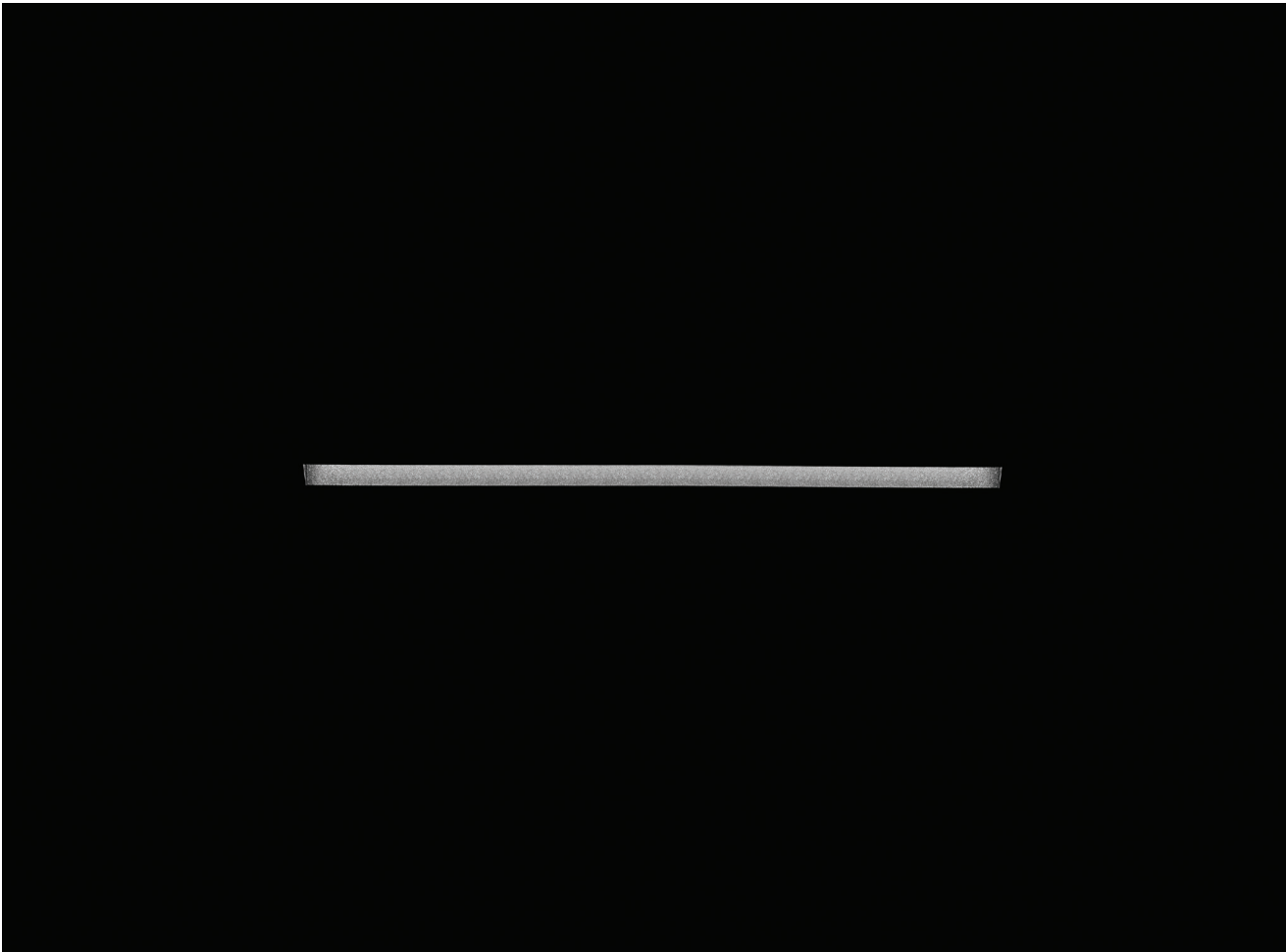

26

^{EN} Traceline Deep Recessed - 500mm
^{IT} Traceline Deep Recessed - 500mm

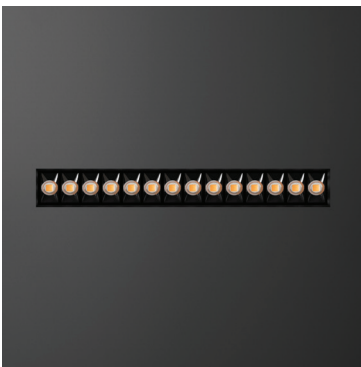

^{EN} Traceline Recessed - Dark Performance diffuser
^{IT} Traceline Recessed - Diffusore Dark Performance

Traceline Deep Recessed finishes:



EN **C0** Royal matt white
IT **C0** Bianco opaco royal



EN **12** Embossed matt white
IT **12** Bianco opaco goffrato

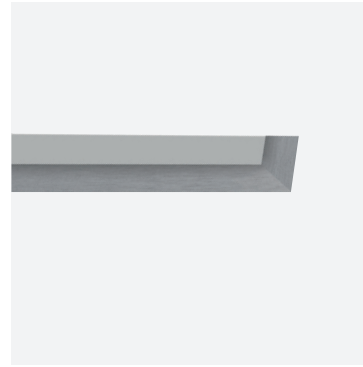

EN **M0** Brushed aluminium
IT **M0** Alluminio spazzolato



EN **B0** Royal Matt Black
IT **B0** Nero opaco royal



EN **31** Embossed matt black
IT **31** Nero opaco goffrato



EN **01** Chrome plated
IT **01** Cromo



EN **E0** Brushed gold
IT **E0** Oro spazzolato



EN **L0** Antiqued brushed bronze
IT **L0** Bronzo antico spazzolato

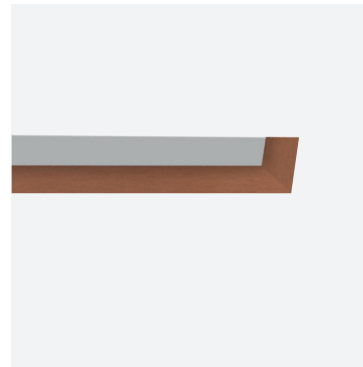

EN **N0** Brushed copper
IT **N0** Rame spazzolato

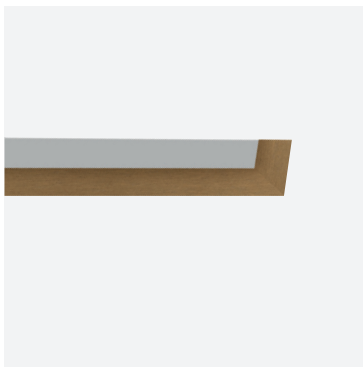

EN **D0** Brushed brass
IT **D0** Ottone spazzolato

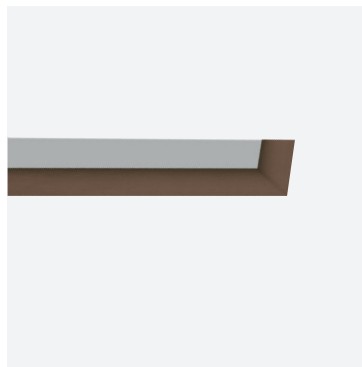

EN **T1** Anodized bronze
IT **T1** Bronzo anodizzato

Traceline

Surface/Pendant

EN Traceline Surface, particularly in the Continuous Line version, can become a distinctive graphic element, to be combined with architectural and design elements, or it can be integrated in coves and architectural details. Thanks to the integrated driver, it can even be installed when there is no false ceiling.

IT Traceline Surface, in particolare nella versione in linea continua, può diventare un elemento grafico distintivo, da combinare con elementi architettonici e di design, oppure può essere integrato in gole e dettagli architettonici. Grazie al driver integrato, può essere installato anche in assenza di controsoffitti.

28

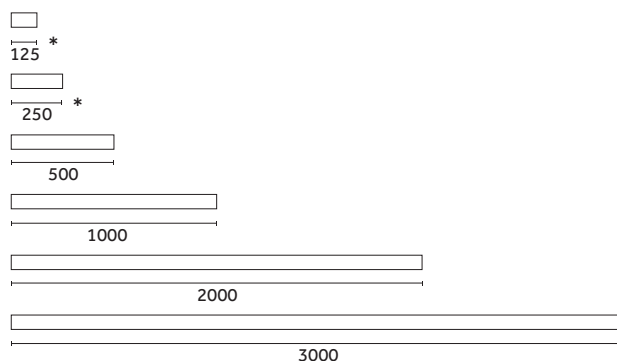
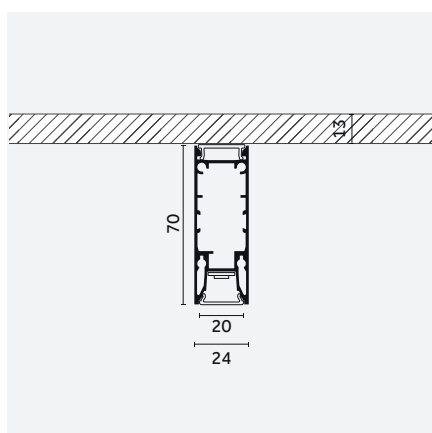

* Dark Performance only

Optical solutions:



Control systems
p.22



Shapes
p.36



Yori Module
p.44



Finishes
p.50

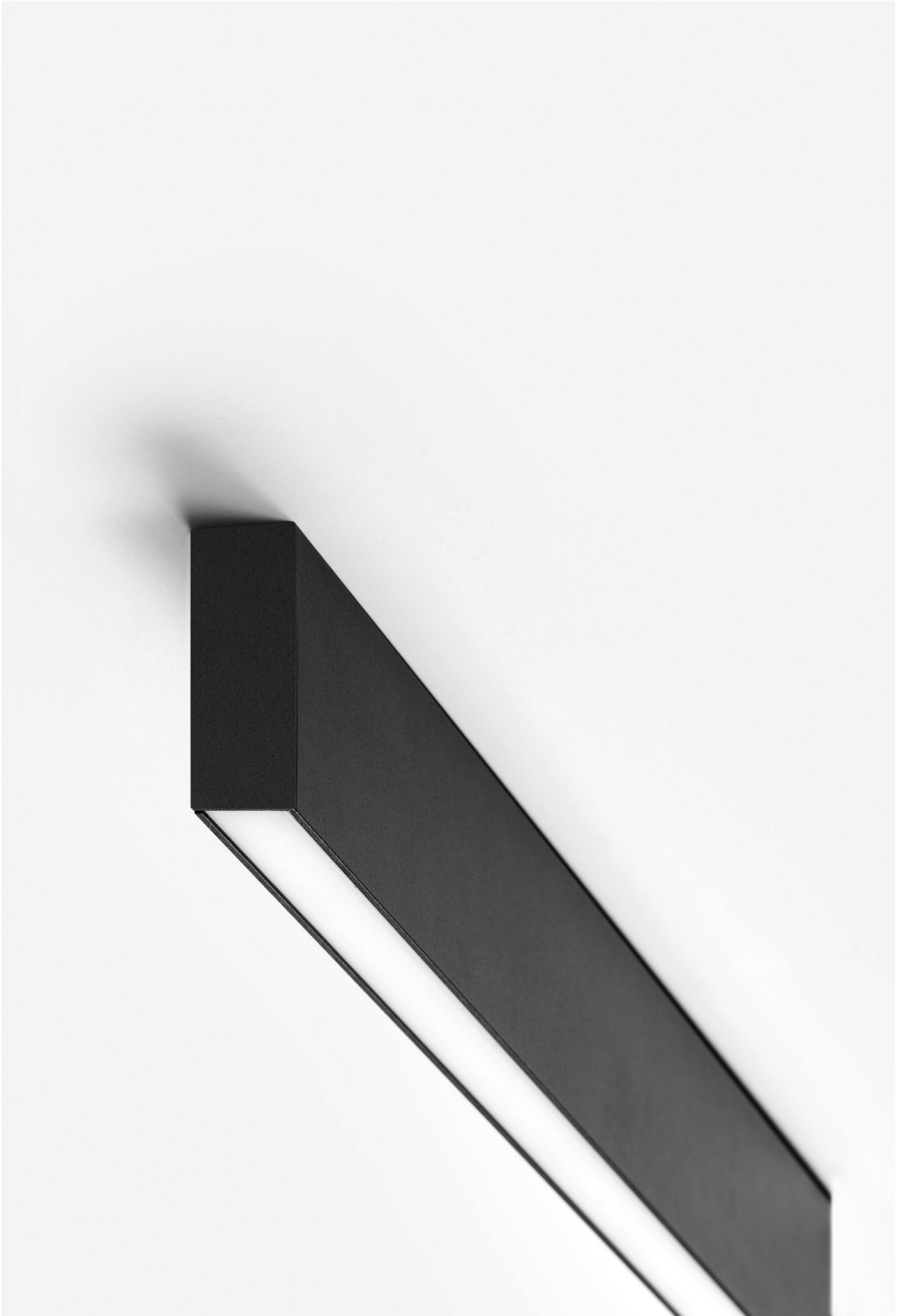

Traceline

EN You can easily turn Traceline Surface into a pendant and wall luminaire using the bespoke accessories, both for single modules and for continuous line configuration.

IT È possibile trasformare facilmente Traceline Surface in un apparecchio a sospensione o a parete, utilizzando gli accessori personalizzati, sia per i moduli singoli che per la configurazione in linea continua.

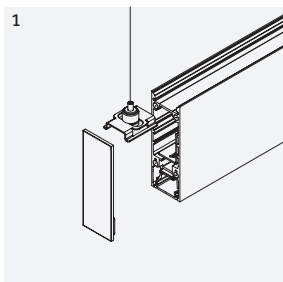

EN Pendant accessory
IT Accessorio per sospensione

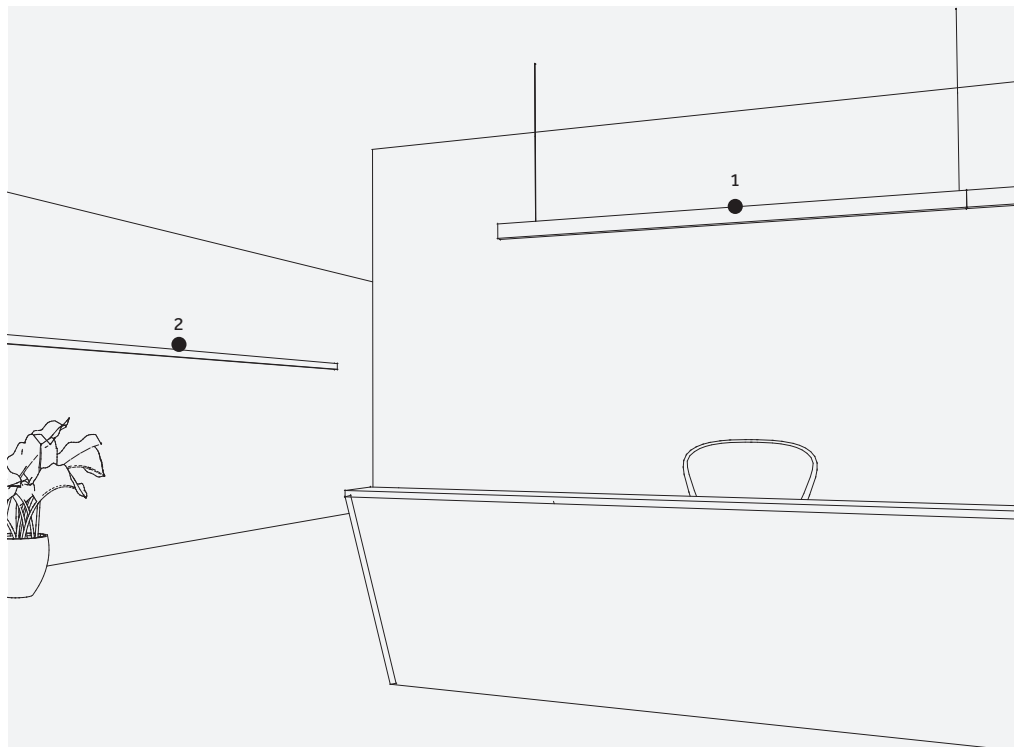

30

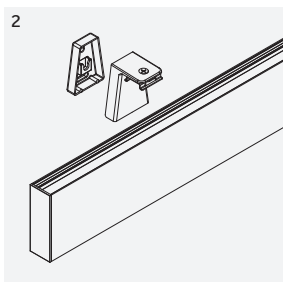

EN Traceline Surface (Wall)
IT Traceline Surface (Parete)

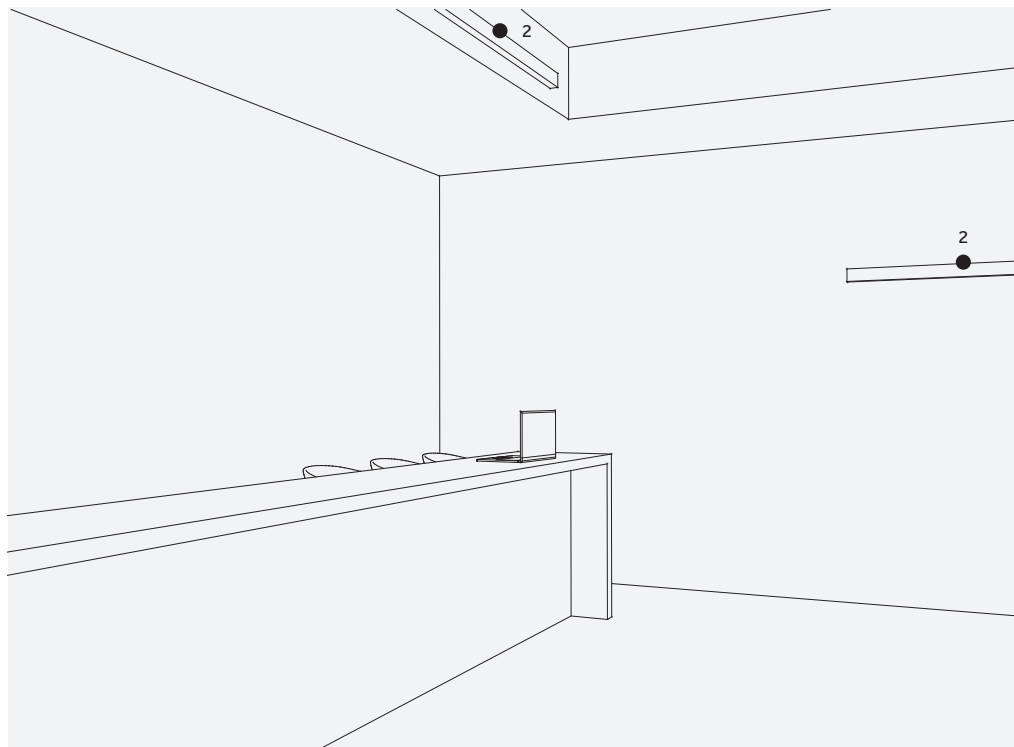



Traceline Pendant

Direct/Indirect

EN Minimalism and understatement encompassed in just 20 mm: Traceline Pendant offers a combination of direct light with visual-comforting indirect lighting to increase light levels and reduce contrasts. It can be installed single configuration and in continuous line, to realize uninterrupted lines of light.

IT Minimalismo e understatement racchiusi in soli 20 mm: Traceline Pendant offre una combinazione di luce diretta, diffusa e di illuminazione indiretta, per aumentare i livelli di illuminamento e ridurre i contrasti. Può essere installato in configurazione singola e in linea continua, per realizzare linee di luce ininterrotte.

32

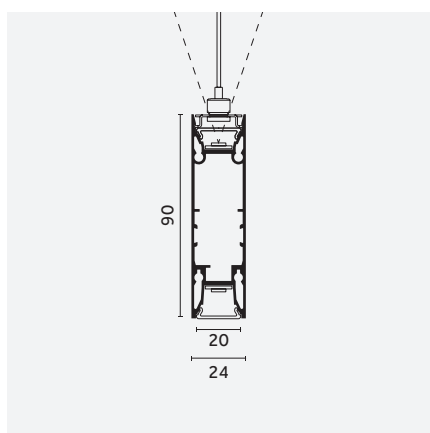

Traceline Pendant - Direct/Indirect

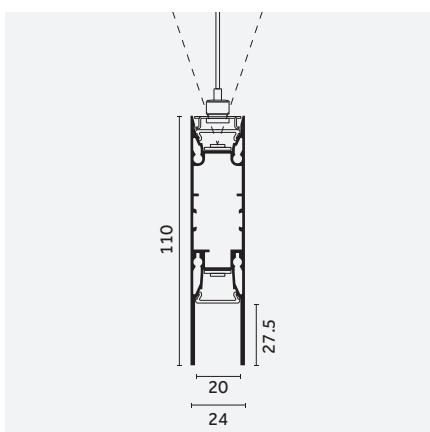
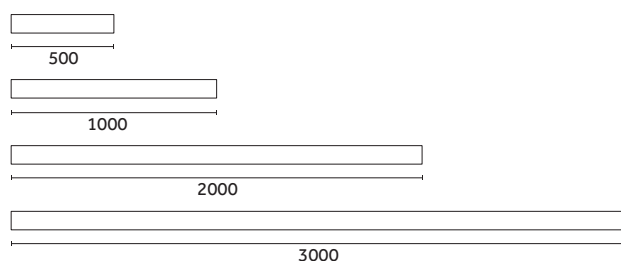

Traceline Deep Pendant - Direct/Indirect

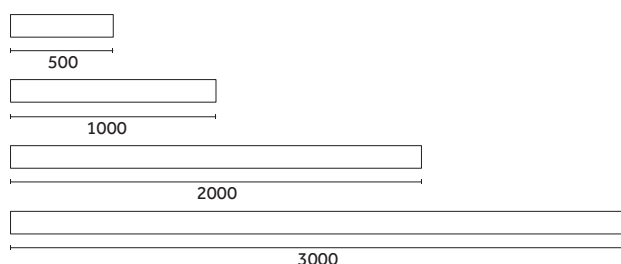



Optical solutions:

-  Lens (11°,48°
-  Opal
-  Micro Prismatic
-  Dark Performance
-  Dark Grid
-  Dark Frosted
(Accessory)



- Control systems
p.22
- Shapes
p.36
- Yori Module
p.44
- Finishes
p.50

^{EN} Power module with 3m cable included
^{IT} Power module con cavo da 3m incluso



EN Surface suspension set
IT Set sospensione a superficie



EN Ghostrack suspension set
IT Set sospensione Ghostrack

34

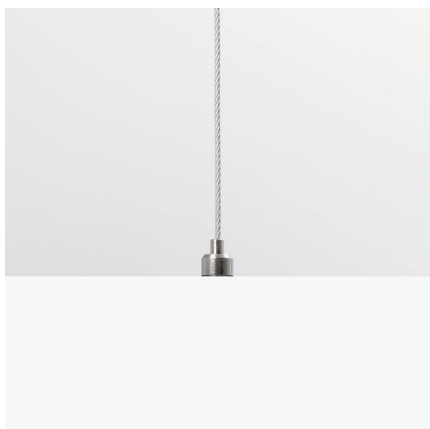

EN Clean and discreet, the joint can be moved at any time to adjust or change your configuration
IT La staffa "a pattino" minimal e discreta, può essere spostata in qualsiasi momento per regolare o modificare la tua configurazione.



Traceline

Angles and squares

^{EN} More than just linear lighting: Traceline offers you the freedom to play with squares and angles of different sizes. They can be Deep Recessed, Recessed, Surface, Pendant or Deep Pendant. Remoted driver for the Recessed versions and integrated controls for Surface and Pendant versions. Traceline Squares and angles are unique architectural and decorative solutions with performing optical options and outstanding colour finishes.

^{IT} Più che una semplice illuminazione lineare. Traceline ti offre la libertà di giocare con quadrati e forme di diverse dimensioni e applicazioni: Deep Recessed, Recessed, Surface, Deep Pendant e Pendant. Driver remoto per le versioni da incasso e controlli integrati per versioni Surface e Pendant. I quadrati e gli angoli sono soluzioni architettoniche e decorative uniche, con opzioni ottiche performanti e straordinarie finiture cromatiche.

36

Modules with light:

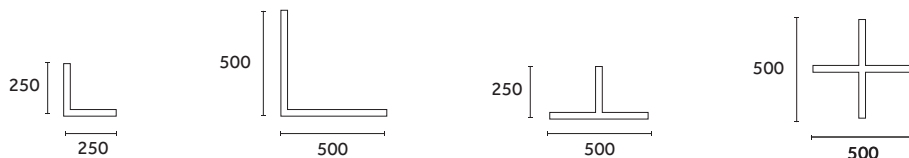

Mechanical joints:

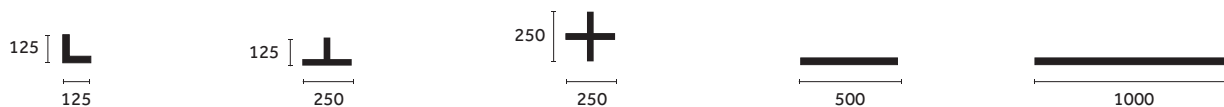

Optical solutions:



Control systems
p.22

Finishes
p.50

^{EN} The modules with light can be used stand alone or with linears to complete your configuration

^{IT} Gli angoli possono essere utilizzati stand alone o con moduli lineari per completare la tua configurazione



Traceline Deep Recessed - "L"
(250x250)

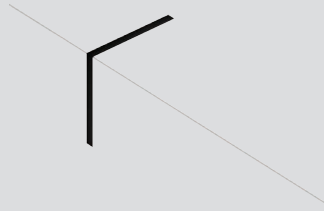

Traceline Deep Recessed - "L Wall"
(250x250)



Traceline Deep Recessed - "T"
(500x250)



Traceline Deep Recessed - "X"
(500x500)



Traceline Recessed - "L"
(250x250)

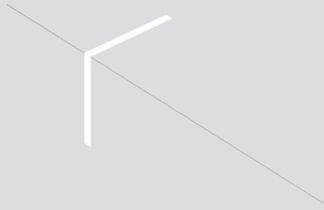

Traceline Recessed - "L Wall"
(250x250)



Traceline Recessed - "T"
(500x250)



Traceline Recessed - "X"
(500x500)

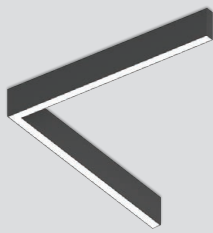

Traceline Surface - "L"
(500x500)

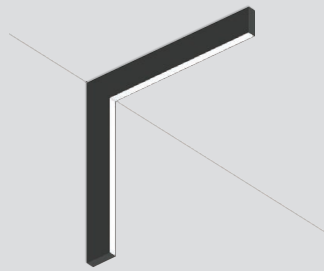

Traceline Surface - "L Wall"
(500x500)



Traceline Surface - "T"
(500x250)

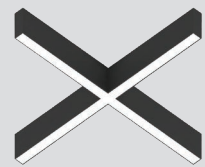

Traceline Surface - "X"
(500x500)

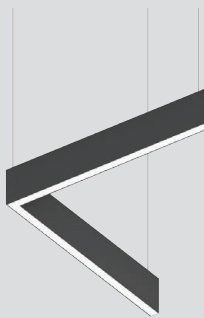

Traceline Pendant - "L"
(500x500)

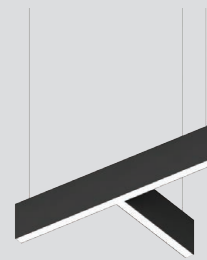

Traceline Pendant - "T"
(500x250)

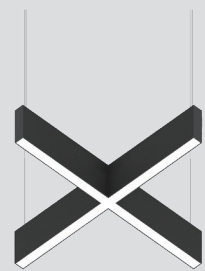

Traceline Pendant - "X"
(500x500)

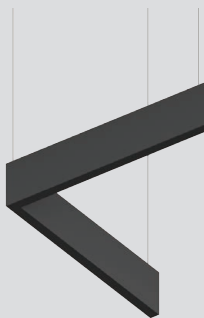

Traceline Deep Pendant - "L"
(500x500)

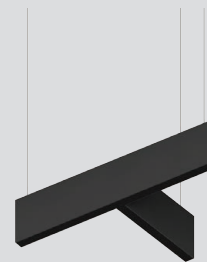

Traceline Deep Pendant - "T"
(500x250)

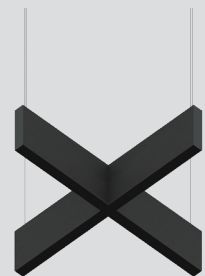

Traceline Deep Pendant - "X"
(500x500)

Squares applications:

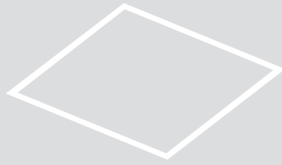
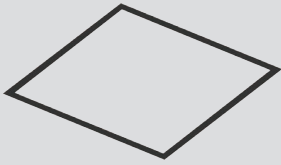

Traceline Deep Recessed Square

Traceline Recessed Square

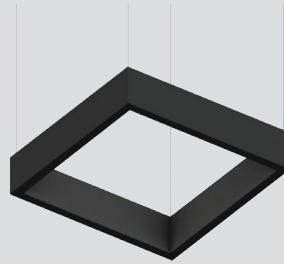
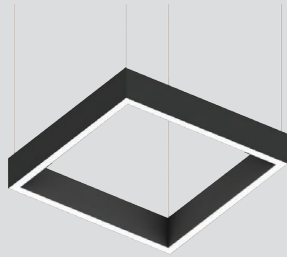
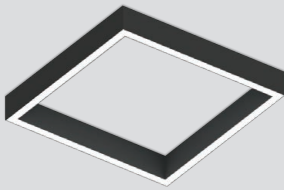

Traceline Surface Square

Traceline Pendant Direct/Indirect Square

Traceline Deep Pendant Direct/Indirect Square

38

Choose the size:



250x250



500x500



750x750

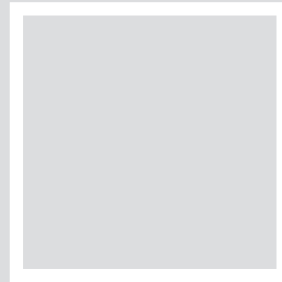

1000x1000

Optical solutions:



Lens (11°,48°)



Opal



Micro Prismatic



Dark Performance



Dark Grid



Dark Frosted (Accessory)



Control systems
p.22



Finishes
p.50







Continuous line

EN Traceline is available in single modules or in a continuous line configuration. The continuous option has been designed to offer the flexibility to create graphic light patterns and emphasize architectural lines. The continuous configuration can carry on adding other Power and Continuous modules without no limitations.

IT Traceline è disponibile in moduli singoli o nella configurazione in linea continua. La linea continua è stata progettata per offrire la flessibilità necessaria per creare pattern grafici luminosi e valorizzare linee e volumi architettonici. Nella configurazione in linea continua puoi aggiungere moduli Power e Continuous senza limitazioni.

42

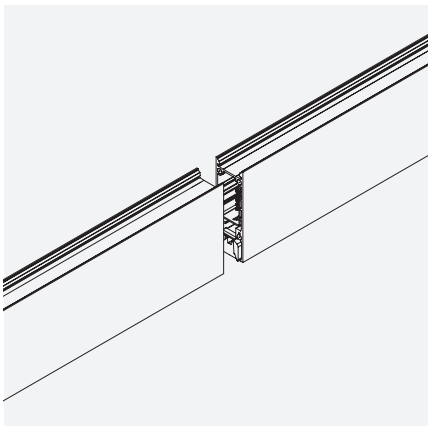

Traceline Surface/Pendant
Traceline Pendant Direct/Indirect

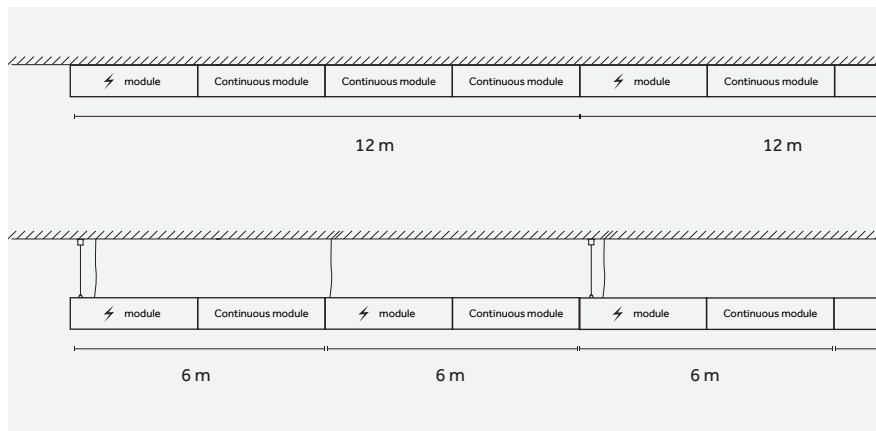

Traceline Recessed

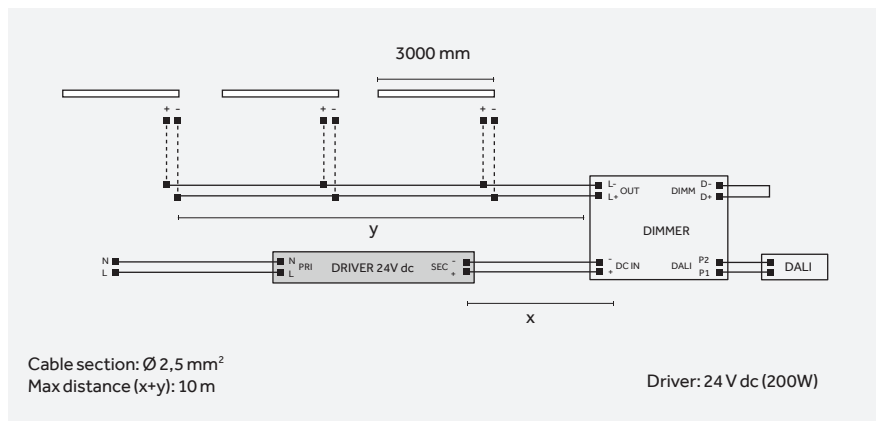

Configuration example: 3x Traceline Recessed - Dark Performance (3000 mm)



Traceline Yori Modules

EN Complement your project with accent lighting: to offer even more design flexibility, Traceline gives you the possibility to integrate any Yori Evo Ghostrack luminaire.

IT Per integrare illuminazione d'accento ovunque sia necessario e offrire ancora più flessibilità di progettazione, Traceline è disponibile nella versione Yori Module, compatibile con qualunque apparecchio Yori Evo Ghostrack.

44

Modules:

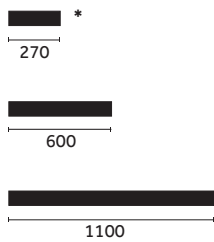

*Recessed only

What can you fit in?

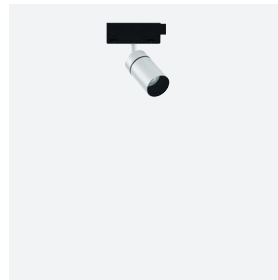

Yori Evo Ghostrack



Yori Ghostrack Pendant

Applications:

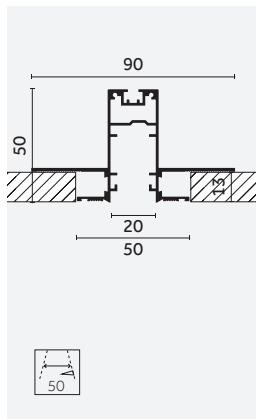

Recessed Trimless

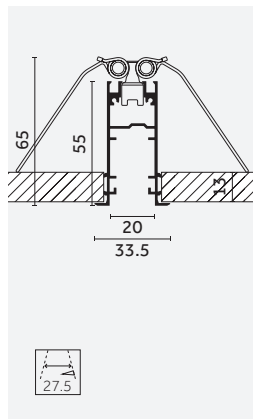

Recessed Trim

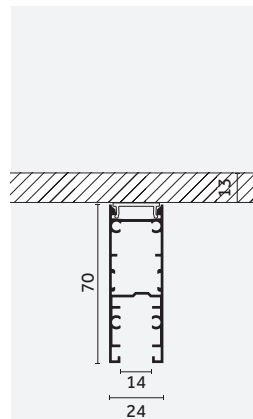

Surface/Pendant

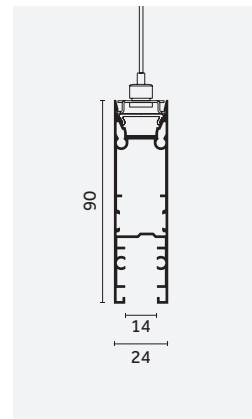

Pendant

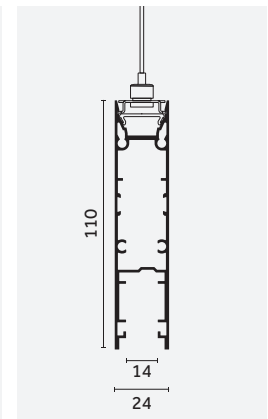

Deep Pendant



45

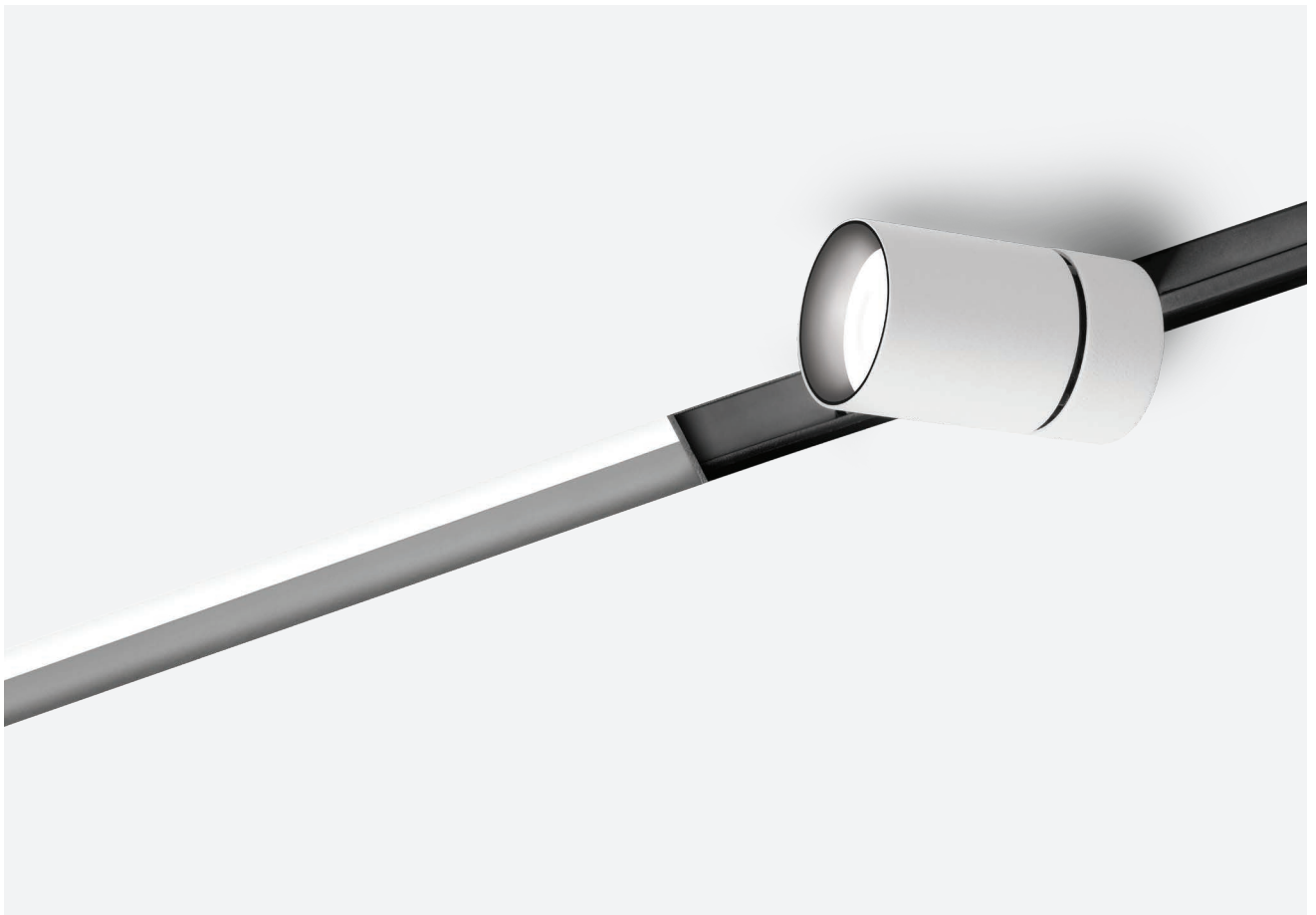

Traceline

Modules

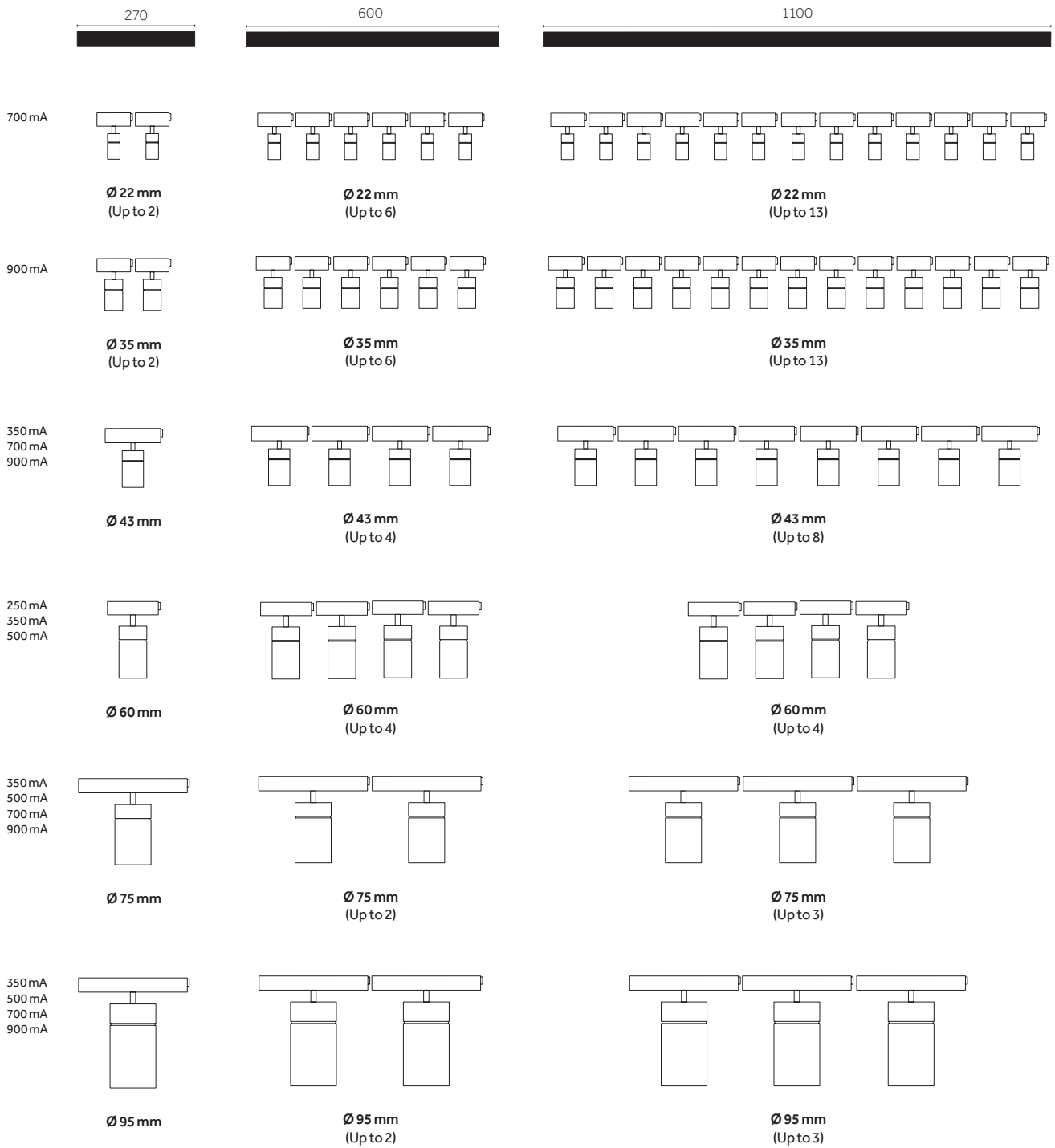

What can you fit in?
 - Yori Evo Ghostrack
 - Yori Pendant Ghostrack

For more info visit: reggiani.net

^{EN} Yori Ø75 mm and Yori Ø95 mm cannot be mounted on Traceline Pendant and Deep Pendant
^{IT} Yori Ø75 mm e Yori Ø95 mm non possono essere montati su Traceline Pendant and Deep Pendant

Configuration examples:

Recessed

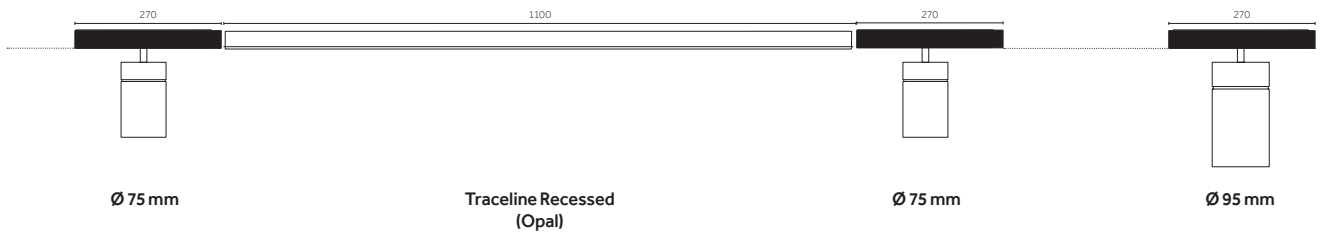

Surface

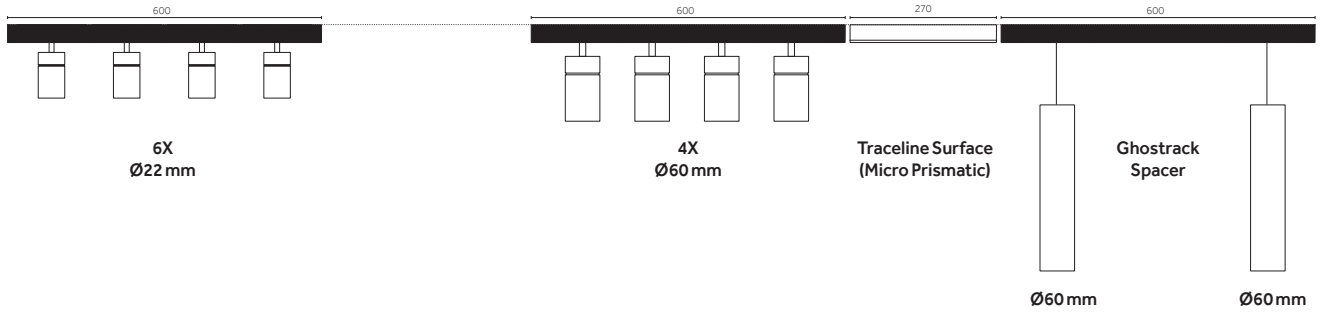

Pendant

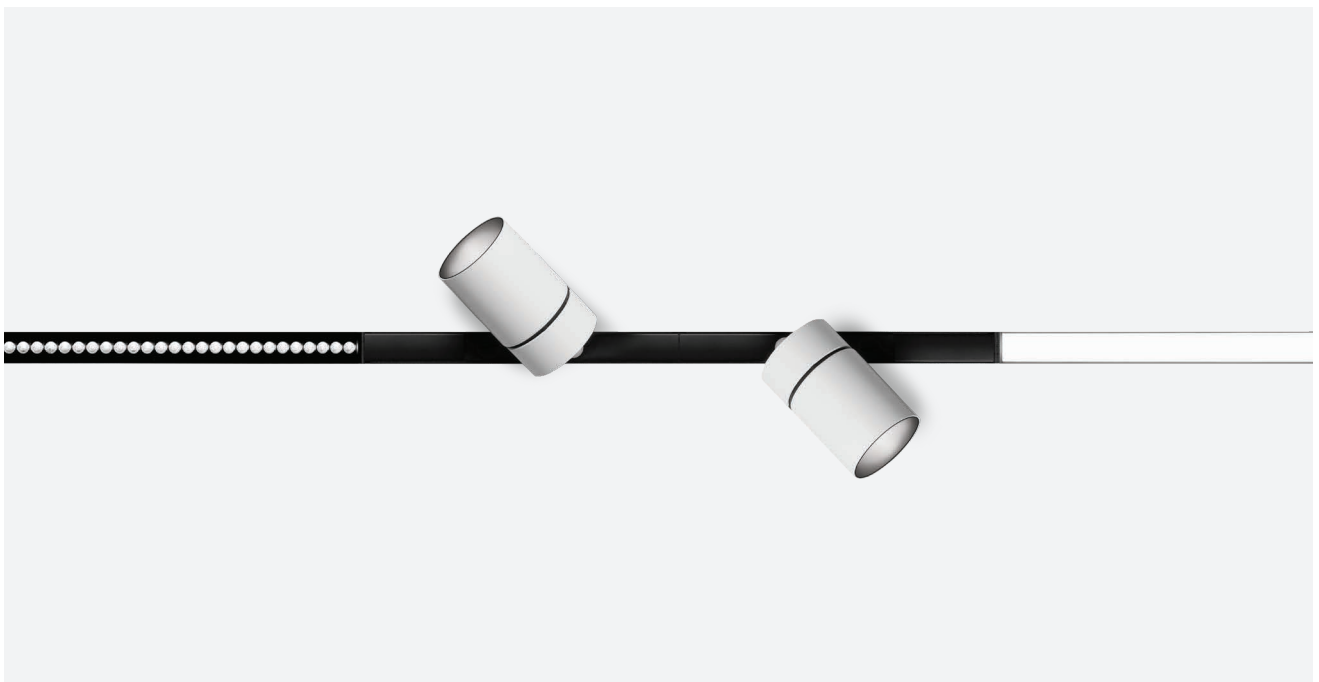
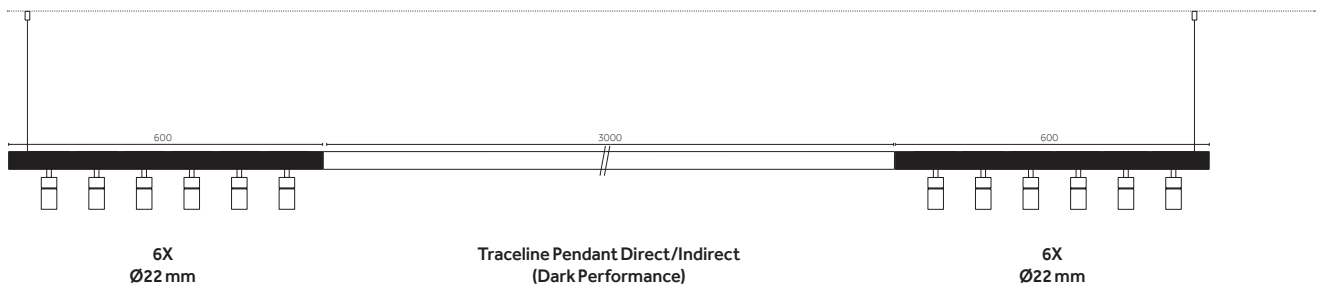

Fade: complete your lighting scheme

EN Minimalism and understatement encompassed in just 22,5 mm and 12 mm height: Fade offers the flexibility of a unique small profile with different combinations of LED Tapes and three different diffusers. A series of mounting accessories allows the integration in any architecture, display or furnishing detail.

IT Minimalismo e understatement racchiusi in soli 22,5 mm di larghezza e 12 mm di altezza: Fade offre la flessibilità di un profilo dalle dimensioni estremamente ridotte con diverse combinazioni di tape LED e tre diversi diffusori. Una serie di accessori di montaggio consente l'integrazione in qualsiasi architettura, vetrina o dettaglio d'arredo.

Create your Fade:

48



Length: up to 3000 mm

Choose the diffuser:



Choose the light temperature:

LED	Warm Dimming (1800-2700 K)	CRI > 90	IP 20
	Tunable White (2200-6500 K)	CRI > 90	IP 20
	Standard (2200, 2700, 3000, 3500, 4000 K)	CRI > 95	IP 20
	IP65 (2200, 2700, 3000, 3500, 4000 K)	CRI > 90	IP 65

For product codes visit: reggiani.net

Fixing system:

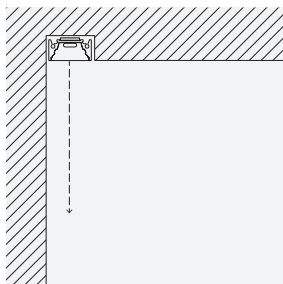

EN Double sided tape
IT Tape biadesivo

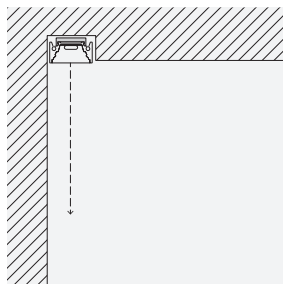

EN Surface bracket
IT Staffa a superficie

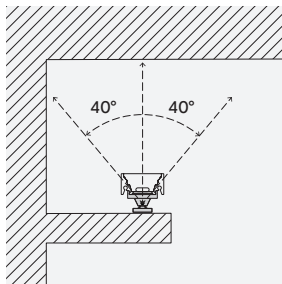

EN Adjustable bracket
IT Staffa orientabile

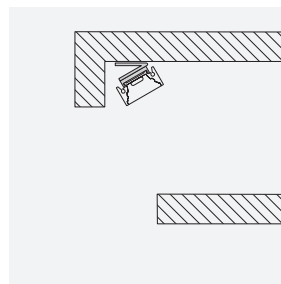

EN Tilted fixed Bracket (15°/30°/45°/60°)
IT Staffa fissa orientata (15°/30°/45°/60°)



Finishes

50

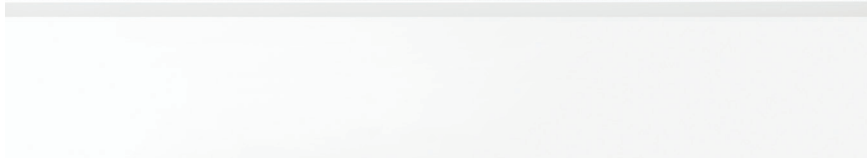

^{EN} 12 Embossed matt white
^{IT} 12 Bianco opaco goffrato

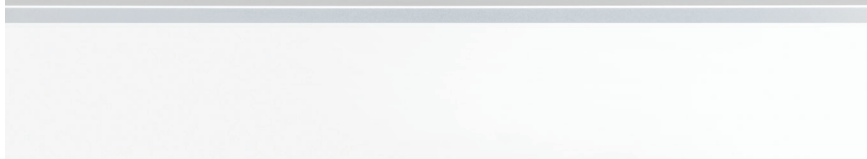

^{EN} C0 Royal matt white
^{IT} C0 Bianco opaco royal



EN **01** Chrome plated
IT **01** Cromo



EN **31** Embossed matt black
IT **31** Nero opaco goffrato



EN **B0** Royal Matt Black
IT **B0** Nero opaco royal



^{EN} **M0** Brushed aluminium
^{IT} **M0** Alluminio spazzolato



^{EN} **D0** Brushed brass
^{IT} **D0** Ottone spazzolato



^{EN} **E0** Brushed gold
^{IT} **E0** Oro spazzolato



EN **T1** Anodized bronze
IT **T1** Bronzo anodizzato



EN **L0** Antiqued brushed bronze
IT **L0** Bronzo antico spazzolato



EN **N0** Brushed copper
IT **N0** Rame spazzolato



EN Custom finishes and patterns by water transfer printing available on request.
IT Finiture e pattern speciali tramite cubicoltura disponibili su richiesta.

Codes

Traceline Deep Recessed

Angles/Corners - Availability: Q4 2019

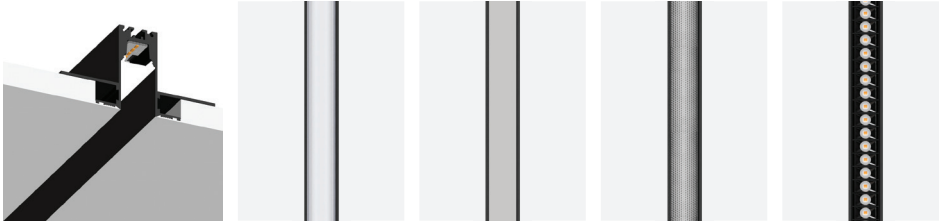

Deep Recessed		Lens 11°		Opal		Micro Prismatic		Dark Performance	
		Trim	Trimless	Trim	Trimless	Trim	Trimless	Trim	Trimless
500	MO	10,5 W	—	—	—	—	—	FN32L	FN52L
	HO	3,7 W	—	—	—	—	—	—	—
	HO	14 W	DN33B	DN53B	DN31H	DN51H	DN33M	DN53M	—
			DN33H	DN53H	DN33H	DN53H	—	—	—
1000	MO	21 W	—	—	—	—	—	FN35L	FN55L
	HO	7,3 W	—	—	—	—	—	—	—
	HO	28 W	DN36B	DN56B	DN34H	DN54H	DN36M	DN56M	—
			DN36H	DN56H	DN36H	DN56H	—	—	—
2000	MO	42 W	—	—	—	—	—	FN39L	FN59L
	HO	14,6 W	—	—	—	—	—	—	—
	HO	56 W	DN3TB	DN5TB	DN37H	DN57H	DN3TM	DN5TM	—
			DN3TH	DN5TH	DN3TH	DN5TH	—	—	—
3000	MO	63 W	—	—	—	—	—	FN3UL	FN5UL
	HO	21,9 W	—	—	—	—	—	—	—
	HO	84 W	DN3UB	DN5UB	DN38H	DN58H	DN3UM	DN5UM	—
			DN3UH	DN5UH	DN3UH	DN5UH	—	—	—
250x250	MO	10,5 W	—	—	—	—	—	UN32L	UN52L
	HO	3,7 W	—	—	—	—	—	—	—
	HO	14 W	TN33B	TN53B	TN31H	TN51H	TN33M	TN53M	—
			TN33H	TN53H	TN33H	TN53H	—	—	—
Ceiling Wall 250x250	MO	10,5 W	—	—	—	—	—	ZN32L	ZN52L
	HO	3,7 W	—	—	—	—	—	—	—
	HO	14 W	VN33B	VN53B	VN31H	VN51H	VN33M	VN53M	—
			VN33H	VN53H	VN33H	VN53H	—	—	—
500x250	MO	15,7 W	—	—	—	—	—	WN33L	WN53L
	HO	5,5 W	—	—	—	—	—	—	—
	HO	21 W	XN34B	XN54B	XN32H	XN52H	XN34M	XN54M	—
			XN34H	XN54H	XN34H	XN54H	—	—	—
500x500	MO	21 W	—	—	—	—	—	YN35L	YN55L
	HO	7,3 W	—	—	—	—	—	—	—
	HO	28 W	KN36B	KN56B	KN34H	KN54H	KN36M	KN56M	—
			KN36H	KN56H	KN36H	KN56H	—	—	—

54

MO=Mid Output, HO= High Output

Create your code:

1. Choose the length
2. Choose the power "W"
3. Choose the diffuser
4. Select your "Product n." (i.e DN33B)
5. Create your code →

NOTE:

- For driver info visit reggiani.net

i.e. X.DN33B.WB01

Driver	Version	LED	K	CRI	Finishes
X. Not included	DN33B	.DT*	1700-2800	>90	01
	<i>Example</i>	.QT*	2200-6500	>90	12
		.WB	2200	>90	31
		.HW	2700	>90	B0
		.HQ	3000	>90	C0
		.HC**	3000	>95	D0
		.WQ	3500	>90	E0
		.HN	4000	>90	L0
					M0
					N0
					T1

* Opal diffuser only

** Dark Performance only

Recessed

Traceline Recessed

Angles/Corners - Availability: Q4 2019

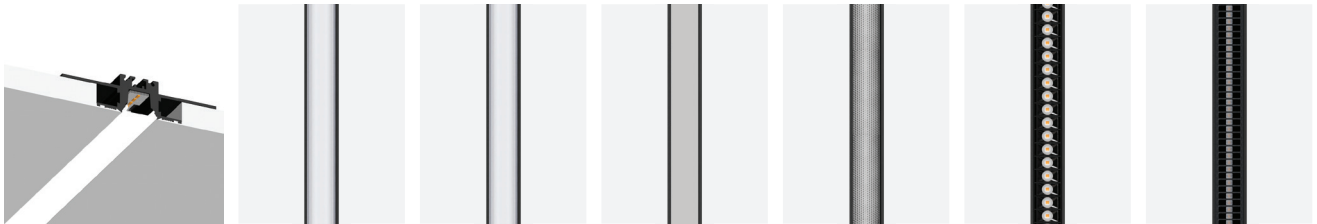

Recessed		Lens 11°		Lens 48°		Opal		Micro Prismatic		Dark Performance		Dark Grid	
		Trim	Trimless	Trim	Trimless	Trim	Trimless	Trim	Trimless	Trim	Trimless	Trim	Trimless
125	2,6 W	—	—	—	—	—	—	—	—	CN30L	CN50L	—	—
		—	—	—	—	—	—	—	—	—	—	—	—
250	5,2 W	—	—	—	—	—	—	—	—	CN31L	CN51L	—	—
		—	—	—	—	—	—	—	—	—	—	—	—
500	10,5 W	—	—	—	—	—	—	—	—	CN32L	CN52L	—	—
	3,7 W	—	—	—	—	—	—	—	—	—	—	—	—
HO	14 W	BN33B	BN53B	BN33E	BN53E	BN31H	BN51H	BN33M	BN53M	—	—	BN33G	BN53G
	—	—	—	—	—	BN33H	BN53H	—	—	—	—	—	—
1000	21 W	—	—	—	—	—	—	—	—	CN35L	CN55L	—	—
	7,3 W	—	—	—	—	—	—	—	—	—	—	—	—
HO	28 W	BN36B	BN56B	BN36E	BN56E	BN34H	BN54H	BN36M	BN56M	—	—	BN36G	BN56G
	—	—	—	—	—	BN36H	BN56H	—	—	—	—	—	—
2000	42 W	—	—	—	—	—	—	—	—	CN39L	CN59L	—	—
	14,6 W	—	—	—	—	—	—	—	—	—	—	—	—
HO	56 W	BN3TB	BN5TB	BN3TE	BN5TE	BN37H	BN57H	BN3TM	BN5TM	—	—	BN3TG	BN5TG
	—	—	—	—	—	BN3TH	BN5TH	—	—	—	—	—	—
3000	63 W	—	—	—	—	—	—	—	—	CN3UL	CN5UL	—	—
	21,9 W	—	—	—	—	—	—	—	—	—	—	—	—
HO	84 W	BN3UB	BN5UB	BN3UE	BN5UE	BN38H	BN58H	BN3UM	BN5UM	—	—	BN3UG	BN5UG
	—	—	—	—	—	BN3UH	BN5UH	—	—	—	—	—	—
250x250	10,5 W	—	—	—	—	—	—	—	—	HN32L	HN52L	—	—
	3,7 W	—	—	—	—	—	—	—	—	—	—	—	—
HO	14 W	GN33B	GN53B	GN33E	GN53E	GN31H	GN51H	GN33M	GN53M	—	—	GN33G	GN53G
	—	—	—	—	—	GN33H	GN53H	—	—	—	—	—	—
Ceiling Wall 250x250	10,5 W	—	—	—	—	—	—	—	—	MN32L	MN52L	—	—
	3,7 W	—	—	—	—	—	—	—	—	—	—	—	—
HO	14 W	LN33B	LN53B	LN33E	LN53E	LN31H	LN51H	LN33M	LN53M	—	—	LN33G	LN53G
	—	—	—	—	—	LN33H	LN53H	—	—	—	—	—	—
500x250	15,7 W	—	—	—	—	—	—	—	—	RN33L	RN53L	—	—
	5,5 W	—	—	—	—	—	—	—	—	—	—	—	—
HO	21 W	QN34B	QN54B	QN34E	QN54E	QN32H	QN52H	QN34M	QN54M	—	—	QN34G	QN54G
	—	—	—	—	—	QN34H	QN54H	—	—	—	—	—	—
500x500	21 W	—	—	—	—	—	—	—	—	PN35L	PN55L	—	—
	7,3 W	—	—	—	—	—	—	—	—	—	—	—	—
HO	28 W	NN36B	NN56B	NN36E	NN56E	NN34H	NN54H	NN36M	NN56M	—	—	NN36G	NN56G
	—	—	—	—	—	NN36H	NN56H	—	—	—	—	—	—

MO=Mid Output, HO= High Output

Create your code:

1. Choose the length
2. Choose the power "W"
3. Choose the diffuser
4. Select your "Product n." (i.e DN33B)
5. Create your code →

NOTE:
- For driver info visit reggiani.net

i.e. X.CN30L.WB01

Driver	Version	LED	K	CRI	Finishes***
X. Not included	CN30L	.DT*	1700-2800	>90	01
	<i>Example</i>	.QT*	2200-6500	>90	12
		.WB	2200	>90	31
		.HW	2700	>90	B0
		.HQ	3000	>90	C0
		.HC**	3000	>95	D0
		.WQ	3500	>90	E0
		.HN	4000	>90	L0
					M0
					N0
					T1

* Opal diffuser only
** Dark Performance only
*** Traceline Recessed Trimless in 12, 31 only

Surface/Pendant

Traceline Surface/Pendant

Angles/Corners - Availability: Q4 2019

Surface /Pendant		Lens 11°		Lens 48°		Opal		Micro Prismatic		Dark Performance		Dark Grid	
		Single	Continuous	Single	Continuous	Single	Continuous	Single	Continuous	Single	Continuous	Single	Continuous
125	2,6 W	—		—		—		—		X.0120L* —		—	
		—		—		—		—		X.V120L* —		—	
		—		—		—		—		X.D120L* —		—	
		—		—		—		—		X.H120L* —		—	
250	5,2 W	—		—		—		—		0.0250L* —		—	
		—		—		—		—		X.0250L* —		—	
		—		—		—		—		X.V250L* —		—	
		—		—		—		—		X.D250L* —		—	
		—		—		—		—		X.H250L* —		—	
500	10,5 W	—		—		—		—		CN82L CP52L		—	
	3,7 W	—		—		—		—		—		—	
MO	14 W	BN83B	BP53B	BN83E	BP53E	BN81H	BP51H	BN83H	BP53H	BN83M	BP53M	BN83G	BP53G
		HO	—		—		—		—		—		—
1000	21 W	—		—		—		—		CN85L CP55L		—	
	7,3 W	—		—		—		—		—		—	
MO	28 W	BN86B	BP56B	BN86E	BP56E	BN84H	BP54H	BN86H	BP56H	BN86M	BP56M	BN86G	BP56G
		HO	—		—		—		—		—		—
2000	42 W	—		—		—		—		CN89L CP59L		—	
	14,6 W	—		—		—		—		—		—	
MO	56 W	BN8TB	BP5TB	BN8TE	BP5TE	BN87H	BP57H	BN8TH	BP5TH	BN8TM	BP5TM	BN8TG	BP5TG
		HO	—		—		—		—		—		—
3000	63 W	—		—		—		—		CN8UL CP5UL		—	
	21,9 W	—		—		—		—		—		—	
MO	84 W	BN8UB	BP5UB	BN8UE	BP5UE	BN88H	BP58H	BN8UH	BP5UH	BN8UM	BP5UM	BN8UG	BP5UG
		HO	—		—		—		—		—		—
500x500	21 W	—		—		—		—		HN82L HP52L		—	
	7,3 W	—		—		—		—		—		—	
MO	28 W	GN83B	GP53B	GN83E	GP53E	GN81H	GP51H	GN83H	GP53H	GN83M	GP53M	GN83G	GP53G
		HO	—		—		—		—		—		—
Ceiling Wall	21 W	—		—		—		—		MN82L MP52L		—	
	7,3 W	—		—		—		—		—		—	
500x500	28 W	LN83B	LP53B	LN83E	LP53E	LN81H	LP51H	LN83H	LP53H	LN83M	LP53M	LN83G	LP53G
		HO	—		—		—		—		—		—
500x250	15,7 W	—		—		—		—		RN83L RP53L		—	
	5,5 W	—		—		—		—		—		—	
MO	21 W	QN84B	QP54B	QN84E	QP54E	QN82H	QP52H	QN84H	QP54H	QN84M	QP54M	QN84G	QP54G
		HO	—		—		—		—		—		—
500x500	21 W	—		—		—		—		PN85L PP55L		—	
	7,3 W	—		—		—		—		—		—	
MO	28 W	NN86B	NP56B	NN86E	NP56E	NN84H	NP54H	NN86H	NP56H	NN86M	NP56M	NN86G	NP56G
		HO	—		—		—		—		—		—

56

*(0.) Driver included On/Off, (X.) Driver not included - All dimmer included: (.V) Dimm 1-10; (.D) DALI; (.H) Bluetooth

MO=Mid Output, HO= High Output

Create your code:

1. Choose the length
2. Choose the power "W"
3. Choose the diffuser
4. Select your "Product n." (i.e DN33B)
5. Create your code →

i.e. 0.BN83B.WB01

Driver	Version	LED	K	CRI	Finishes
0. On/Off	BN83B	.DT**	1700-2800	>90	01
V. Dimm 1-10	Example	.QT**	2200-6500	>90	12
D. DALI		.WB	2200	>90	31
H. Bluetooth		.HW	2700	>90	B0
		.HQ	3000	>90	C0
		.HC***	3000	>95	D0
		.WQ	3500	>90	E0
		.HN	4000	>90	L0
					M0
					N0
					T1

** Opal diffuser only
*** Dark Performance only

Pendant

Traceline Pendant Direct/Indirect

Angles/Corners - Availability: Q4 2019

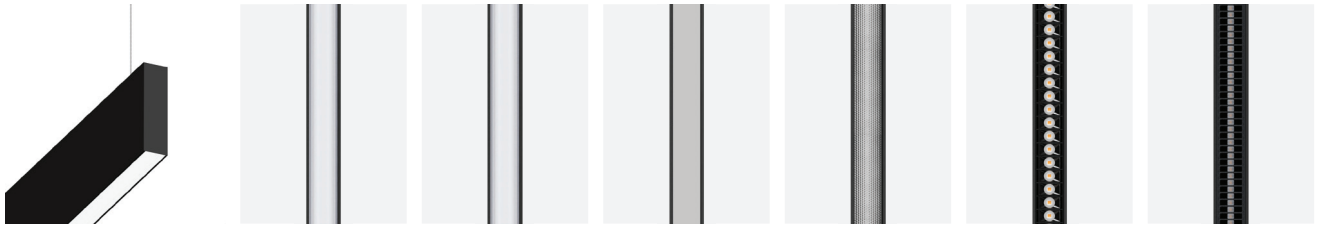

Pendant		Lens 11°		Lens 48°		Opal		Micro Prismatic		Dark Performance		Dark Grid	
		≠ Single Continuous		≠ Single Continuous		≠ Single Continuous		≠ Single Continuous		≠ Single Continuous		≠ Single Continuous	
500	MO	10,5 W	—	—	—	—	—	—	—	FN82N	FP52N	—	—
	HO	3,7 W	—	—	—	—	—	—	—	—	—	—	—
		14 W		DN83P	DP53P	DN83Q	DP53Q	DN83R	DP53R	DN83T	DP53T	—	—
		Indirect light: 14 W											
1000	MO	21 W	—	—	—	—	—	—	—	FN85N	FP55N	—	—
	HO	7,3 W	—	—	—	—	—	—	—	—	—	—	—
		28 W		DN86P	DP56P	DN86Q	DP56Q	DN86R	DP56R	DN86T	DP56T	—	—
		Indirect light: 28 W											
2000	MO	42 W	—	—	—	—	—	—	—	FN89N	FP59N	—	—
	HO	14,6 W	—	—	—	—	—	—	—	—	—	—	—
		56 W		DN8TP	DP5TP	DN8TQ	DP5TQ	DN8TR	DP5TR	DN8TT	DP5TT	—	—
		Indirect light: 56 W											
3000	MO	63 W	—	—	—	—	—	—	—	FN8UN	FP5UN	—	—
	HO	21,9 W	—	—	—	—	—	—	—	—	—	—	—
		84 W		DN8UP	DP5UP	DN8UQ	DP5UQ	DN8UR	DP5UR	DN8UT	DP5UT	—	—
		Indirect light: 84 W											
500x500	MO	21 W	—	—	—	—	—	—	—	UN85N	UP55N	—	—
	HO	7,3 W	—	—	—	—	—	—	—	—	—	—	—
		28 W		TN86P	TP56P	TN86Q	TP56Q	TN86R	TP56R	TN86T	TP56T	—	—
		Indirect light: 28 W											
500x250	MO	15,7 W	—	—	—	—	—	—	—	YN83N	YP53N	—	—
	HO	5,5 W	—	—	—	—	—	—	—	—	—	—	—
		21 W		KN84P	KP54P	KN84Q	KP54Q	KN84R	KP54R	KN84T	KP54T	—	—
		Indirect light: 21 W											
500x500	MO	21 W	—	—	—	—	—	—	—	ZN85N	ZP55N	—	—
	HO	7,3 W	—	—	—	—	—	—	—	—	—	—	—
		28 W		VN86P	VP56P	VN86Q	VP56Q	VN86R	VP56R	VN86T	VP56T	—	—
		Indirect light: 28 W											

Indirect light:
 - Separate control for Dimm 1-10 (not 500), DALI and Bluetooth options
 - Single control for On/Off

MO=Mid Output, HO=High Output

Create your code:

1. Choose the length
2. Choose the power "W"
3. Choose the diffuser
4. Select your "Product n." (i.e DN33B)
5. Create your code →

i.e. 0.DN83P.WB01

Driver	Version	LED	K	CRI	Finishes
0. On/Off	DN83P	.DT*	1700-2800	>90	01
V. Dimm 1-10	Example	.QT*	2200-6500	>90	12
D. DALI		.WB	2200	>90	31
H. Bluetooth		.HW	2700	>90	B0
		.HQ	3000	>90	C0
		.HC**	3000	>95	D0
		.WQ	3500	>90	E0
		.HN	4000	>90	L0
					M0
					N0
					T1

* Opal diffuser only
 ** Dark Performance only

Deep Pendant

Traceline Deep Pendant Direct/Indirect

Angles/Corners - Availability: Q4 2019

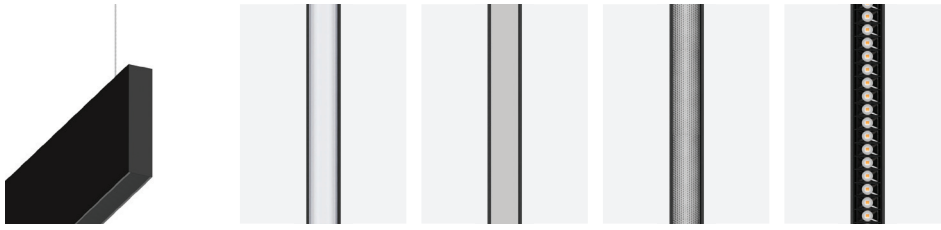

Deep Pendant		Lens 11°		Opal		Micro Prismatic		Dark Performance	
		Single	Continuous	Single	Continuous	Single	Continuous	Single	Continuous
500	MO	10,5 W	—	—	—	—	—	2N82N	2P52N
	HO	3,7 W	—	—	1N81R	1P51R	—	—	—
		14 W	1N83P	1P53P	1N83R	1P53R	1N83T	1P53T	—
Indirect light: 14 W									
1000	MO	21 W	—	—	—	—	—	2N85N	2P55N
	HO	7,3 W	—	—	1N84R	1P54R	—	—	—
		28 W	1N86P	1P56P	1N86R	1P56R	1N86T	1P56T	—
Indirect light: 28 W									
2000	MO	42 W	—	—	—	—	—	2N89N	2P59N
	HO	14,6 W	—	—	1N87R	1P57R	—	—	—
		56 W	1N8TP	1P5TP	1N8TR	1P5TR	1N8TT	1P5TT	—
Indirect light: 56 W									
3000	MO	63 W	—	—	—	—	—	2N8UN	2P5UN
	HO	21,9 W	—	—	1N88R	1P58R	—	—	—
		84 W	1N8UP	1P5UP	1N8UR	1P5UR	1N8UT	1P5UT	—
Indirect light: 84 W									
500x500	MO	21 W	—	—	—	—	—	WN85N	WP55N
	HO	7,3 W	—	—	XN84R	XP54R	—	—	—
		28 W	XN86P	XP56P	XN86R	XP56R	XN86T	XP56T	—
Indirect light: 28 W									
500x250	MO	15,7 W	—	—	—	—	—	5N83N	5P53N
	HO	5,5 W	—	—	6N82R	6P52R	—	—	—
		21 W	6N84P	6P54P	6N84R	6P54R	6N84T	6P54T	—
Indirect light: 21 W									
500x500	MO	21 W	—	—	—	—	—	3N85N	3P55N
	HO	7,3 W	—	—	4N84R	4P54R	—	—	—
		28 W	4N86P	4P56P	4N86R	4P56R	4N86T	4P56T	—
Indirect light: 28 W									

58

Indirect light:
 - Separate control for Dimm 1-10 (not 500), DALI and Bluetooth options
 - Single control for On/Off

MO=Mid Output, HO=High Output

Create your code:

1. Choose the length
2. Choose the power "W"
3. Choose the diffuser
4. Select your "Product n." (i.e 2N82N)
5. Create your code →

i.e. 0.2N82N.WB01

Driver	Version	LED	K	CRI	Finishes
0. On/Off	2N82N	.DT*	1700-2800	>90	01
V. Dimm 1-10	Example	.QT*	2200-6500	>90	12
D. DALI		.WB	2200	>90	31
H. Bluetooth		.HW	2700	>90	B0
		.HQ	3000	>90	C0
		.HC**	3000	>95	D0
		.WQ	3500	>90	E0
		.HN	4000	>90	L0
					M0
					N0
					T1

* Opal diffuser only
 ** Dark Performance only

Square

Traceline Deep Recessed - Square

Availability: Q4 2019

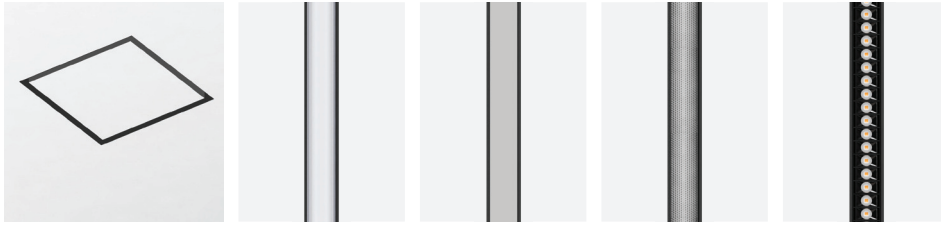

Deep Recessed - Square		Lens 11° Trimless	Opal Trimless	Micro Prismatic Trimless	Dark Performance Trimless
250x250	MO	21 W	—	—	4N55L
	HO	7,3 W	3N53H	—	—
500x500	MO	42 W	—	—	4N59L
	HO	14,6 W	3N57H	—	—
750x750	MO	63 W	—	—	4N55L
	HO	21,9 W	3N58H	—	—
1000x1000	MO	84 W	—	—	4N5VL
	HO	29,2 W	3N59H	—	—
			3N56B	3N56M	
			3N56H	3N56M	
			3N5TB	3N5TM	
			3N5TH	3N5TM	
			3N5UB	3N5UM	
			3N5UH	3N5UM	
			3N5ZB	3N5ZM	
			3N5ZH	3N5ZM	

Traceline Recessed - Square

Availability: Q4 2019

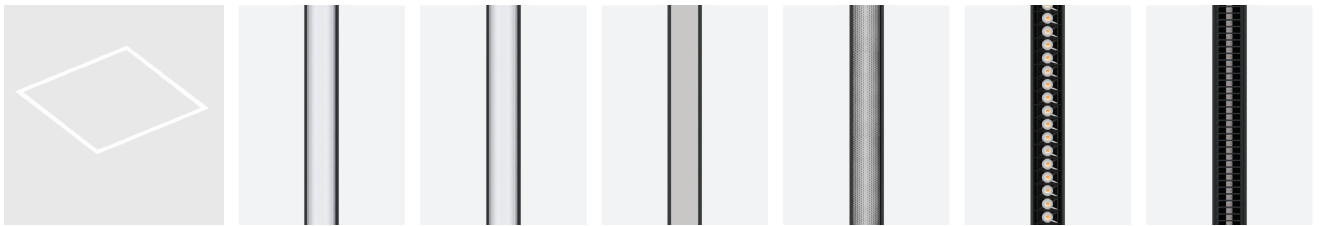

Recessed - Square		Lens 11° Trimless	Lens 48° Trimless	Opal Trimless	Micro Prismatic Trimless	Dark Performance Trimless	Dark Grid Trimless
250x250	MO	21 W	—	—	—	2N55L	—
	HO	7,3 W	—	1N53H	—	—	—
500x500	MO	42 W	—	—	—	2N59L	—
	HO	14,6 W	—	1N57H	—	—	—
750x750	MO	63 W	—	—	—	2N55L	—
	HO	21,9 W	—	1N58H	—	—	—
1000x1000	MO	84 W	—	—	—	2N5VL	—
	HO	29,2 W	—	1N59H	—	—	—
				1N56H	1N56M		1N56G
				1N57H	1N57H		1N57G
				1N58H	1N58H		1N58G
				1N59H	1N59H		1N59G
				1N56E	1N56M		1N56G
				1N57H	1N57H		1N57G
				1N58H	1N58H		1N58G
				1N59H	1N59H		1N59G
				1N56E	1N56M		1N56G
				1N57H	1N57H		1N57G
				1N58H	1N58H		1N58G
				1N59H	1N59H		1N59G

MO=Mid Output, HO= High Output

Create your code:

1. Choose the dimension
2. Choose the power "W"
3. Choose the diffuser
4. Select your "Product n." (i.e 3N56B)
5. Create your code →

i.e. X.3N56B.WB01

Driver	Version	LED	K	CRI	Finishes***
X. Not included	3N56B	.DT*	1700-2800	>90	01
	<i>Example</i>	.QT*	2200-6500	>90	12
		.WB	2200	>90	31
		.HW	2700	>90	B0
		.HQ	3000	>90	C0
		.HC**	3000	>95	D0
		.WQ	3500	>90	E0
		.HN	4000	>90	L0
					M0
					N0
					T1

* Opal diffuser only

** Dark Performance only

*** Traceline Recessed Square in 12, 31 only

Square

Traceline Surface/Pendant - Square

Availability: Q4 2019

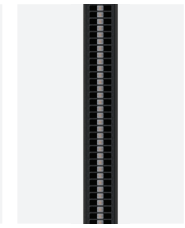
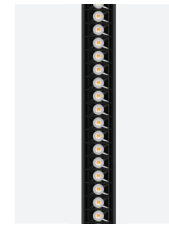
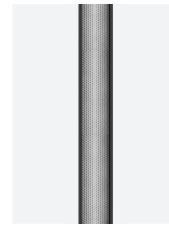
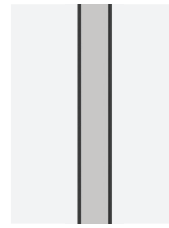
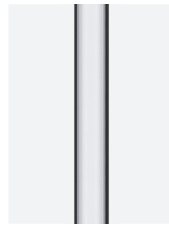
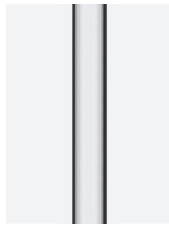
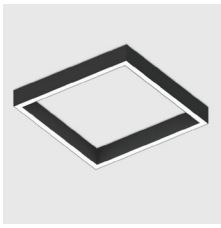

Surface/Pendant - Square

		Lens 11° ↗ Single	Lens 48° ↗ Single	Opal ↗ Single	Micro Prismatic ↗ Single	Dark Performance ↗ Single	Dark Grid ↗ Single
250x250	MO	21 W	—	—	—	CP25L	—
	HO	7,3 W 28 W	—	BP23H BP26H	—	—	—
500x500	MO	42 W	—	—	—	CP29L	—
	HO	14,6 W 56 W	—	BP27H BP2TH	—	—	—
750x750	MO	63 W	—	—	—	CP25L	—
	HO	21,9 W 84 W	—	BP28H BP2UH	—	—	—
1000x1000	MO	84 W	—	—	—	CP2VL	—
	HO	29,2 W 112 W	—	BP29H BP2ZH	—	—	—
			BP26B	BP26E	BP26M	—	BP26G
			BP2TB	BP2TE	BP2TM	—	BP2TG
			BP2UB	BP2UE	BP2UM	—	BP2UG
			BP2ZB	BP2ZE	BP2ZM	—	BP2ZG

60

Traceline Pendant - Direct/Indirect - Square

Availability: Q4 2019

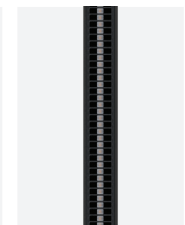
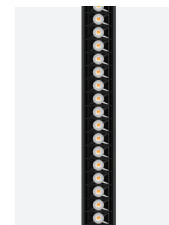
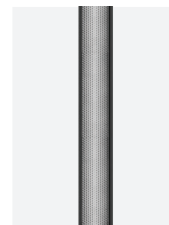
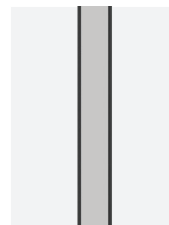
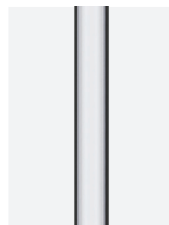
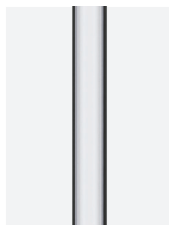

Pendant - Square

		Lens 11° ↗ Single	Lens 48° ↗ Single	Opal ↗ Single	Micro Prismatic ↗ Single	Dark Performance ↗ Single	Dark Grid ↗ Single
250x250	MO	21 W	—	—	—	FP25N	—
	HO	7,3 W 28 W	—	DP23R DP26R	—	—	—
		Indirect light: 28 W					
500x500	MO	42 W	—	—	—	FP29N	—
	HO	14,6 W 56 W	—	DP27R DP2TR	—	—	—
		Indirect light: 56 W					
750x750	MO	63 W	—	—	—	FP25N	—
	HO	21,9 W 84 W	—	DP28R DP2UR	—	—	—
		Indirect light: 84 W					
1000x1000	MO	84 W	—	—	—	FP2VN	—
	HO	29,2 W 112 W	—	DP29R DP2ZR	—	—	—
		Indirect light: 112 W					
			DP26P	DP26Q	DP26T	—	DP26S
			DP2TP	DP2TQ	DP2TT	—	DP2TS
			DP2UP	DP2UQ	DP2UT	—	DP2US
			DP2ZP	DP2ZQ	DP2ZT	—	DP2ZS

Square

Traceline Deep Pendant - Direct/Indirect - Square

Availability: Q4 2019

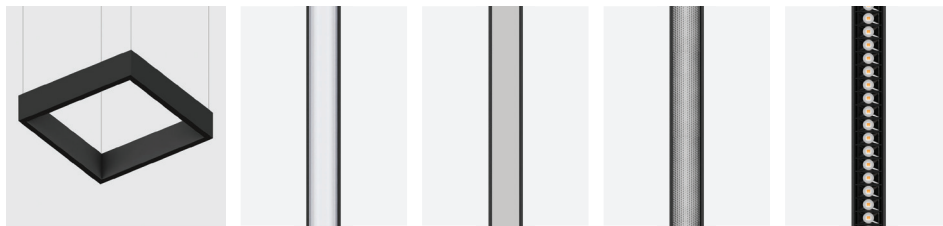

Deep Pendant - Square		Lens 11° ≠ Single	Opal ≠ Single	Micro Prismatic ≠ Single	Dark Performance ≠ Single
250x250	MO	21 W	—	—	HP25N
	HO	7,3 W	GP23R	—	—
		28 W	GP26P	GP26T	—
Indirect light: 28 W					
500x500	MO	42 W	—	—	HP29N
	HO	14,6 W	GP27R	—	—
		56 W	GP2TP	GP2TR	GP2TT
Indirect light: 56 W					
750x750	MO	63 W	—	—	HP2SN
	HO	21,9 W	GP28R	—	—
		84 W	GP2UP	GP2UR	GP2UT
Indirect light: 84 W					
1000x1000	MO	84 W	—	—	HP2VN
	HO	29,2 W	GP29R	—	—
		112 W	GP2ZP	GP2ZR	GP2ZT
Indirect light: 112 W					

Indirect light:
 - Separate control for Dimm 1-10 (not 500), DALI and Bluetooth options
 - Single control for On/Off

MO=Mid Output, HO= High Output

Create your code:

1. Choose the dimension
2. Choose the power "W"
3. Choose the diffuser
4. Select your "Product n." (i.e GP26P)
5. Create your code →

i.e. 0.GP2P.WB01

Driver	Version	LED	K	CRI	Finishes
0. On/Off	GP26P	.DT*	1700-2800	>90	01
V. Dimm 1-10	<i>Example</i>	.QT*	2200-6500	>90	12
D. DALI		.WB	2200	>90	31
H. Bluetooth		.HW	2700	>90	B0
Onrequest		.HQ	3000	>90	C0
		.HC**	3000	>95	D0
		.WQ	3500	>90	E0
		.HN	4000	>90	L0
					M0
					N0
					T1

* Opal diffuser only
 ** Dark Performance only

Yori Module

Traceline Recessed - Yori Module

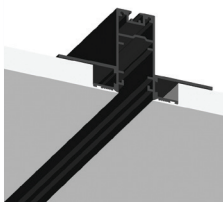

Recessed	Trim	Trimless
270	BM820	HM820
600	BM850	HM850
1100	BM890	HM890

Create your code:

i.e. X.BM820.TS01

1. Choose the dimension
2. Select your "Product n." (i.e BM820)
3. Create your code →

Driver	Version	LED	Finishes
X. Not included	BM820 <i>Example</i>	.TS NO LED	12
			31

- NOTE:**
- For mA settings see p.46
 - For driver info visit reggiani.net

62

Traceline Surface/Pendant - Yori Module

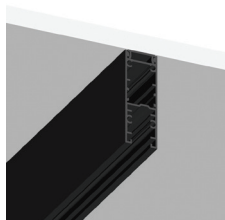

Surface/Pendant	250 mA		350 mA		500 mA		700 mA		800 mA		900 mA	
	Single	Continuous	Single	Continuous	Single	Continuous	Single	Continuous	Single	Continuous	Single	Continuous
600	BM952	UM952	BM953	UM953	BM955	UM955	BM957	UM957	BM958	UM958	BM959	UM959
1100	—	—	—	—	BM995	UM995	BM997	UM997	BM998	UM998	BM999	UM999

Create your code:

i.e. X.BM952.TS01

1. Choose the dimension
2. Choose the mA setting
3. Select your "Product n." (i.e BM952)
4. Create your code →

Driver	Version	LED	Finishes
0. On/Off	BM952 <i>Example</i>	.TS NO LED	01
D. DALI			12
H. Bluetooth On request			31
V. Dimm 1-10			B0
			C0
			D0
			E0
			L0
			M0
			N0
			T1

- NOTE:**
- For mA settings see p.46
 - For complete Yori Spot configurations visit reggiani.net

Yori Module

Traceline Deep Pendant - Yori Spot

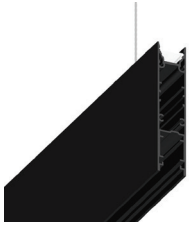

Deep Pendant	250 mA		350 mA		500 mA		700 mA		800 mA		900 mA	
	Single	Continuous	Single	Continuous	Single	Continuous	Single	Continuous	Single	Continuous	Single	Continuous
600*	PM952	3M952	PM953	3M953	PM955	3M955	PM957	3M957	PM958	3M958	PM959	3M959
1100	—	—	—	—	PM995	3M995	PM997	3M997	PM998	3M998	PM999	3M999

Indirect light: 28W

Create your code:

i.e. X.PM952.WB01

1. Choose the dimension
2. Choose the mA setting
3. Select your "Product n." (i.e BM952)
4. Create your code →

NOTE:

- For mA settings see p.46
- For complete Yori Spot configurations visit reggiani.net

Driver	Version	LED	K	CRI	Finishes
O. On/Off	PM952	.DT**	1700-2800	>90	O1
D. DALI	<i>Example</i>	.QT**	2200-6500	>90	12
H. Bluetooth		.WB	2200	>90	31
Onrequest		.HW	2700	>90	B0
V. Dimm 1-10		.HQ	3000	>90	C0
		.WQ	3500	>90	D0
		.HN	4000	>90	E0
		.TS*	NOLED		L0
					M0
					N0
					T1

Traceline Pendant - Yori Module



Pendant	250 mA		350 mA		500 mA		700 mA		800 mA		900 mA	
	Single	Continuous	Single	Continuous	Single	Continuous	Single	Continuous	Single	Continuous	Single	Continuous
600*	HM952	WM952	HM953	WM953	HM955	WM955	HM957	WM957	HM958	WM958	HM959	WM959
1100	—	—	—	—	HM995	WM995	HM997	WM997	HM998	WM998	HM999	WM999

Indirect light: 28 W

Create your code:

i.e. 0.HM952.WB01

1. Choose the dimension
2. Choose the mA setting
3. Select your "Product n." (i.e BM952)
4. Create your code →

NOTE:

- For mA settings see p.46
- For complete Yori Spot configurations visit reggiani.net

Driver	Version	LED	K	CRI	Finishes
O. On/Off	HM952	.DT**	1700-2800	>90	O1
D. DALI	<i>Example</i>	.QT**	2200-6500	>90	12
H. Bluetooth		.WB	2200	>90	31
Onrequest		.HW	2700	>90	B0
V. Dimm 1-10		.HQ	3000	>90	C0
		.WQ	3500	>90	D0
		.HN	4000	>90	E0
		.TS*	NOLED		L0
					M0
					N0
					T1

* Without Indirect Light
** Opal diffuser only

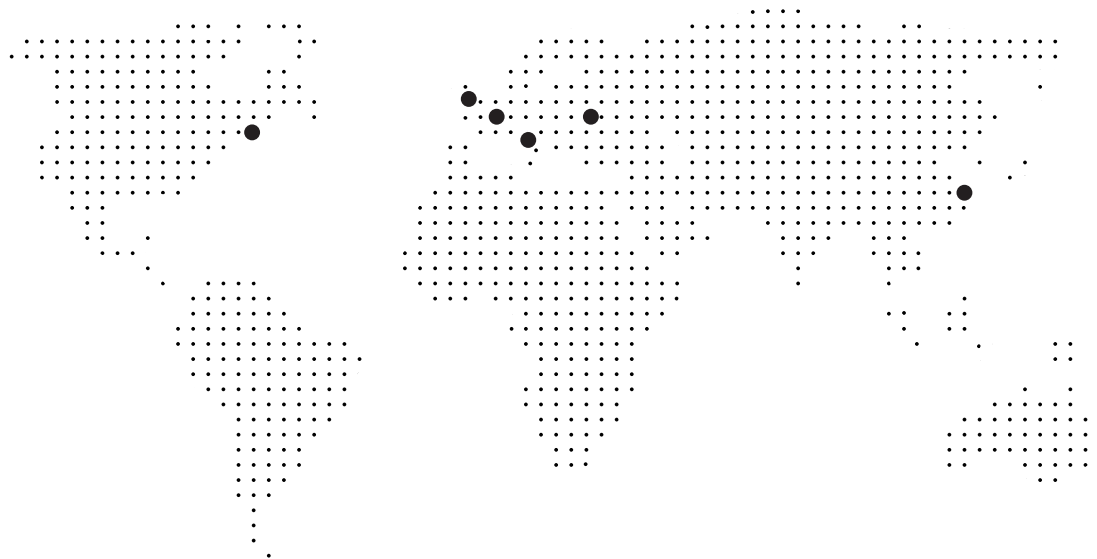

ITALY
Reggiani S.p.A. Illuminazione
Headquarters

Viale Monza 16 P.O. Box 99
20845 Sovico (MB), Italy
T. (+39) 039 20711
F. (+39) 039 2071999
contact@reggiani.net

USA
Reggiani Lighting USA, inc.

372 Starke Road
Carlstadt NJ 07072, USA
T. (+1) 201 372 1717
F. (+1) 201 372 1616
info@reggianiusa.com
www.reggianiusa.com

FRANCE
Sales office

39 Bd. Richard Lenoir, Bastille
75011 Paris, France
T. (+33) 01 43382704
F. (+33) 01 43382720
france@reggiani.net

Worldwide distributors

For the worldwide distributors list visit
www.reggiani.net

UNITED KINGDOM
Reggiani Ltd

12 Chester Road
Borehamwood
Herts, WD6 1LT - UK
T. (+44) 0208 236 3000
F. (+44) 0208 236 3099
reggiani@reggiani.co.uk

CHINA
Reggiani Ningbo ITG Lighting co. Ltd

Shenjia Village - Qiuai Town - Yinzhou
315010 Ningbo, China
T. (+86) 574 88418655 - 88412627
F. (+86) 574 88364186
info@itglight.com

RUSSIA
Sales office

Kalanchevskaya Street, 16,
Building 1, Room 4A, 129090 Moscow
T. (+7) 495 2690113 - 846 3320266
F. (+7) 495 2690112
russia@reggiani.net

©
2019
Reggiani S.p.A. Illuminazione
All rights reserved

Art direction
Reggiani Creative Team

Graphic design
Reggiani Creative Team

Print
Cattaneo Grafiche

Reggiani S.p.A. Illuminazione reserves the right to make technical, design and size changes at any time, without prior notice. Total or partial reproduction of this document is prohibited. Luminaire sizes are given in millimetres. All technical and design innovations are patented. Watts and lumens refer to the nominal values of the LED source; for photometric data and lumen output of the luminaires, visit www.reggiani.net



Reggiani

[theilluminationcollective](https://www.theilluminationcollective.com)

www.reggiani.net

Reggiani