

Accessories Installation

NEO 360 concealed accessories

VI.1

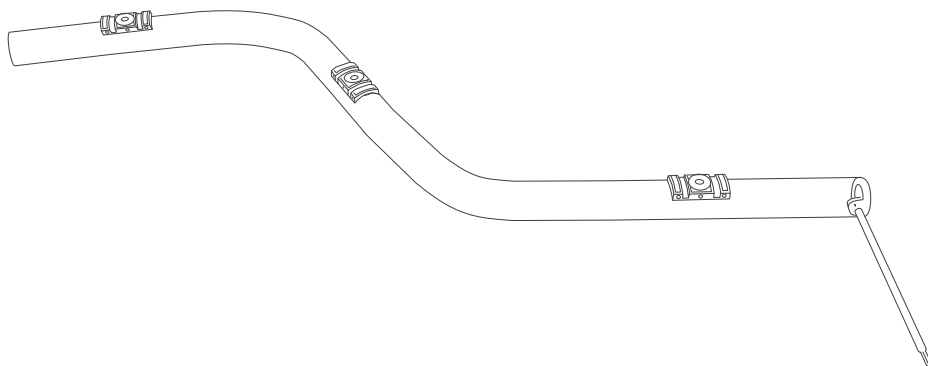

Please read this manual carefully before installation, and install the product in the correct way. Please keep it after reading, so that all users of this product can check it at any time.

Prepare materials

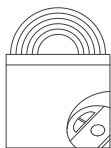

Neo strip



Manual

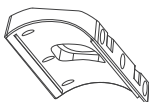

Concealed fixed
buckle



Rubber plug
screw



Steel needle



Rolled strip

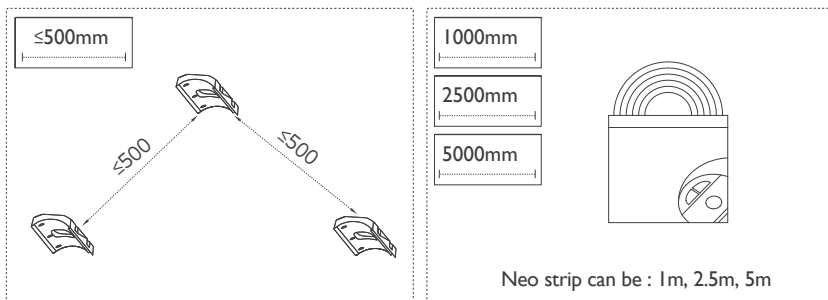

Installation tools



Screwdriver



Pen

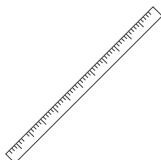

Tape measure

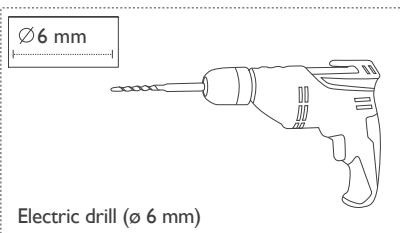



Installation Steps

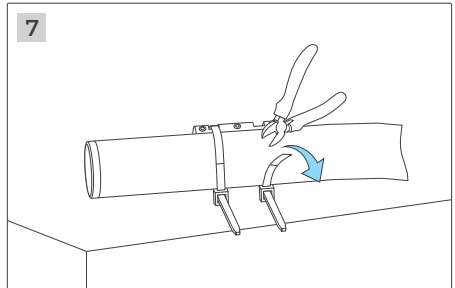
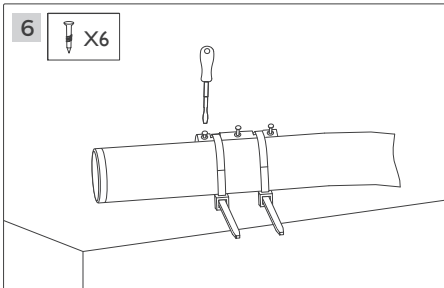
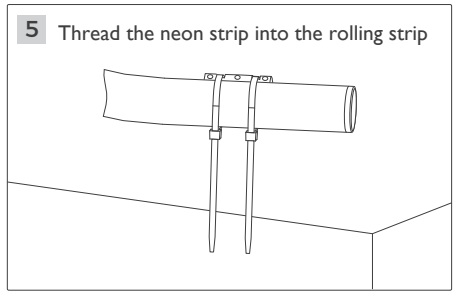
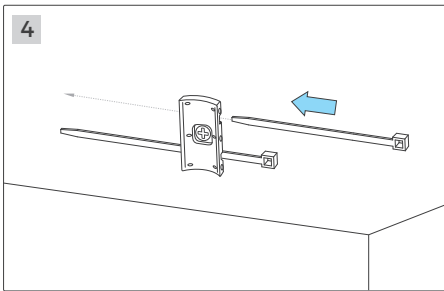
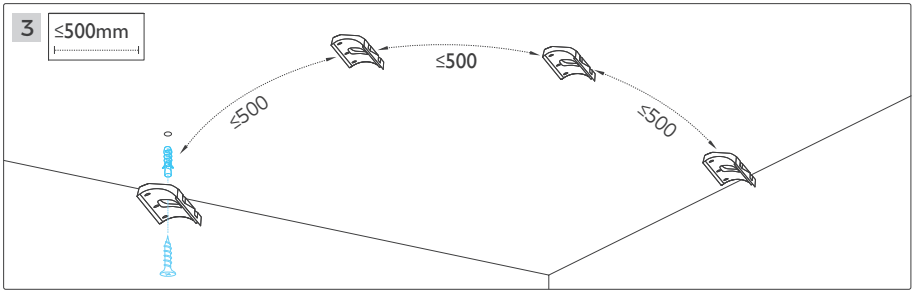
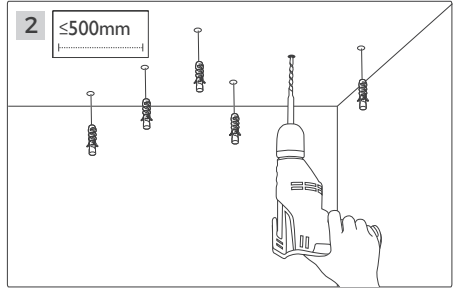
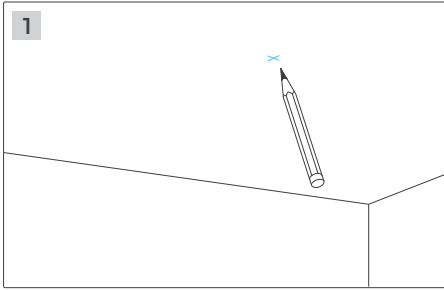

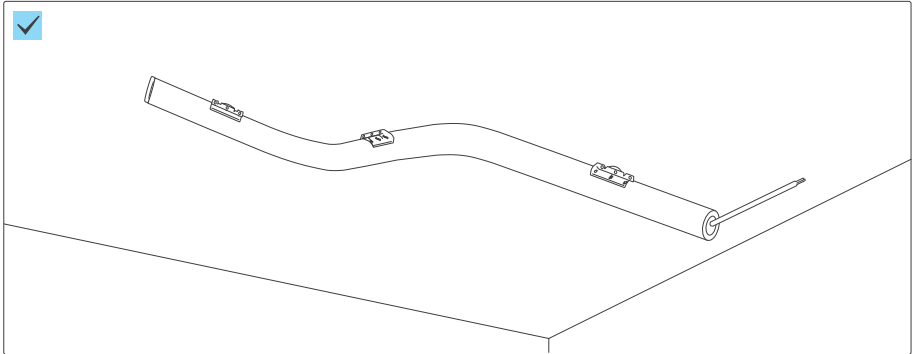

Accessories Installation

Neo 360 Horizontal ceiling mounted accessories

VI.1

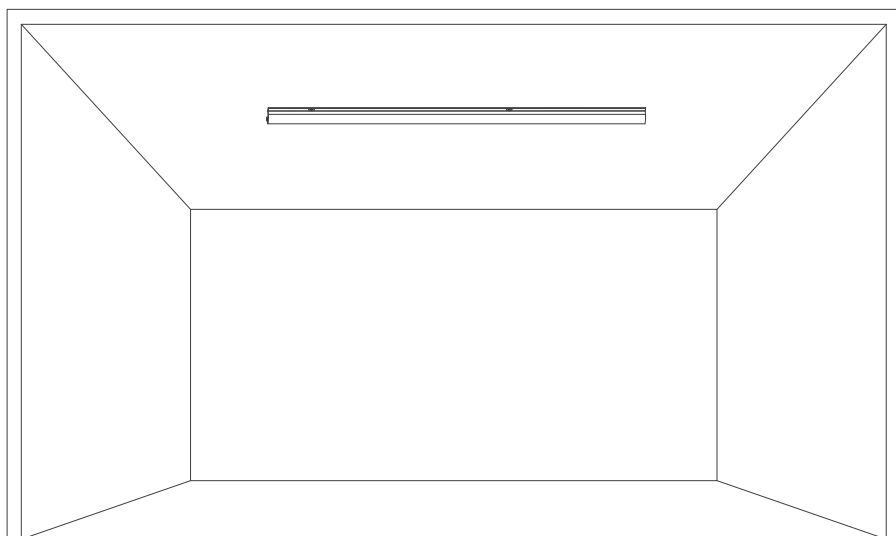

Please read this manual carefully before installation, and install the product in the correct way. Please keep it after reading, so that all users of this product can check it at any time.

Prepare materials

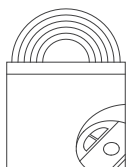

Neo strip



Manual



Rubber plug screw



PC carrier

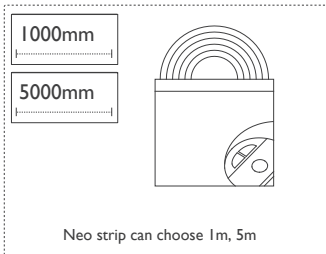
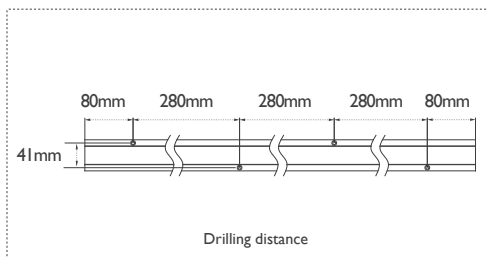

Installation tools



Phillips screwdriver



Pen

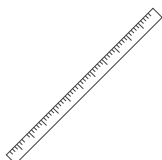

Tape measure

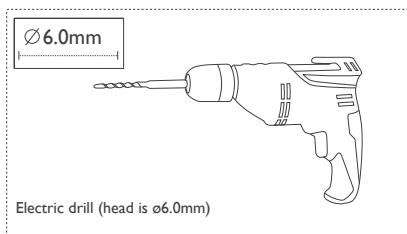



Installation Steps

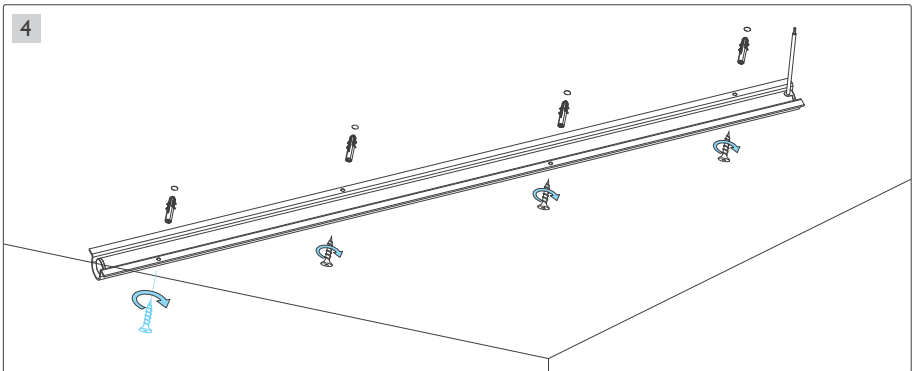
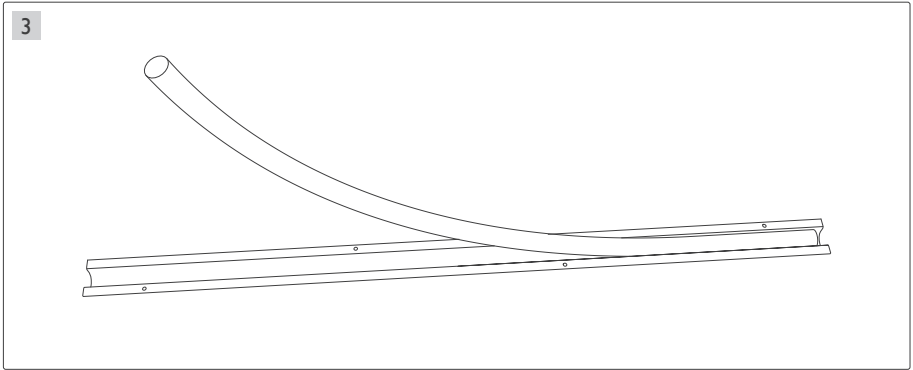
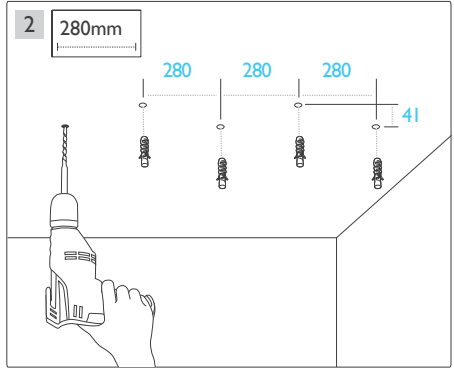
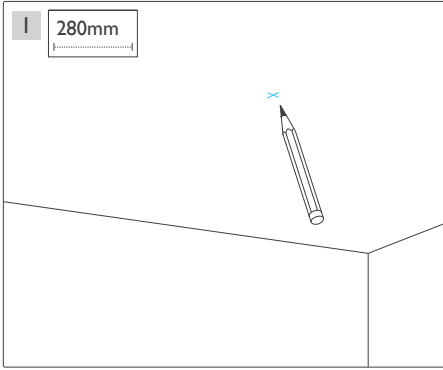

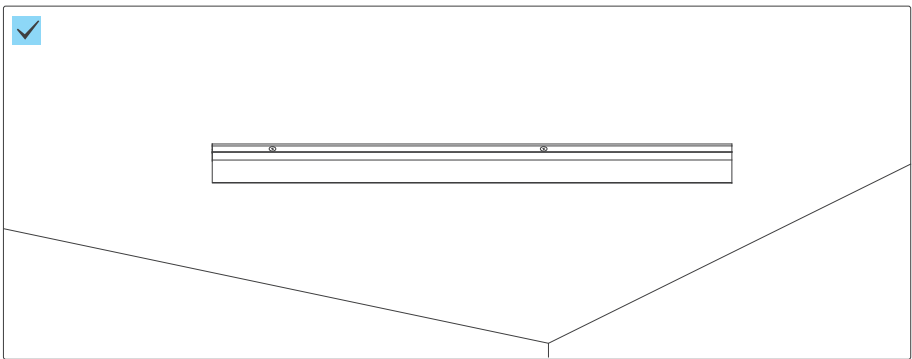

Accessories Installation

Neo 360 Horizontal suspension accessories

VI.1

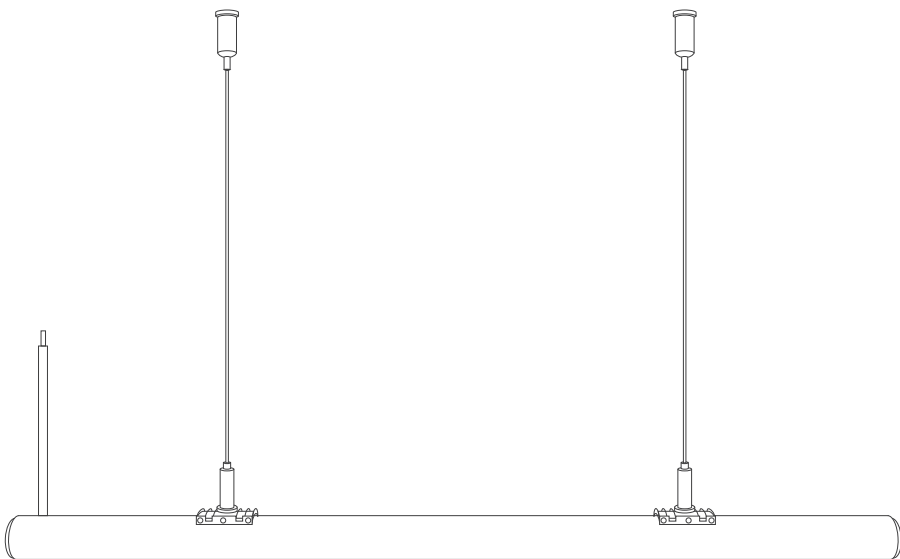

Please read this manual carefully before installation, and install the product in the correct way. Please keep it after reading, so that all users of this product can check it at any time.

Prepare materials

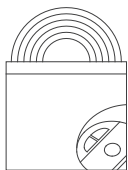

Neo strip



Manual



Rubber plug screw



PC tube



Wire rope

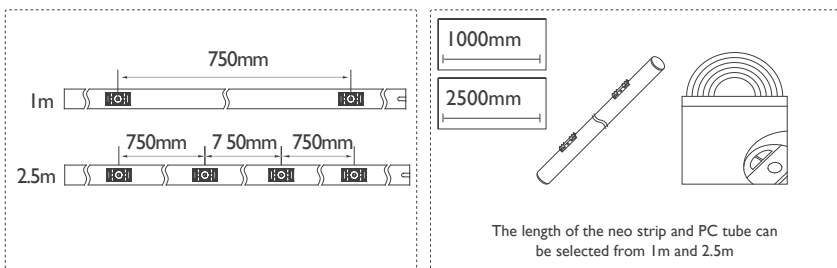

Installation tools



Phillips
screwdriver



Pen

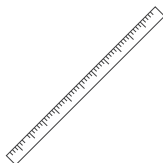

Tape measure

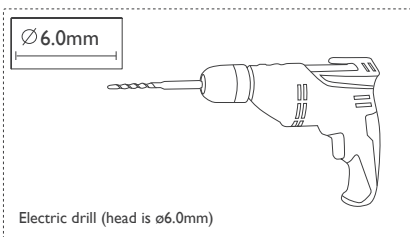

Installation Steps

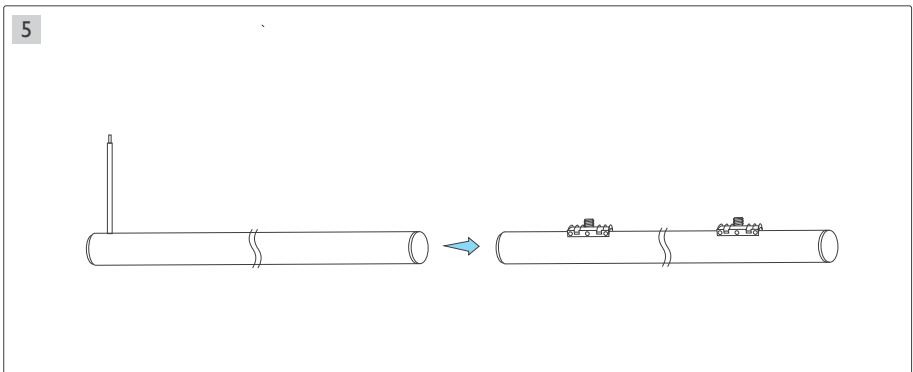
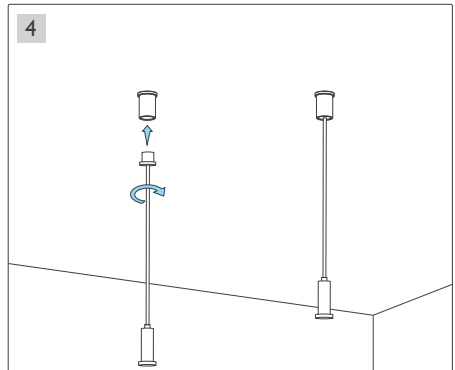
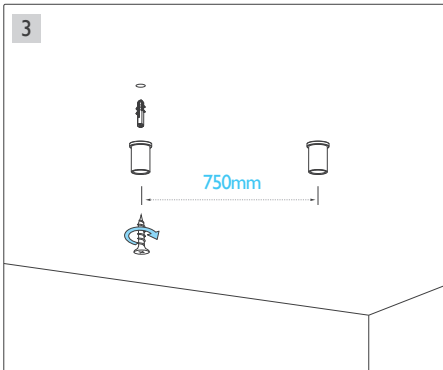
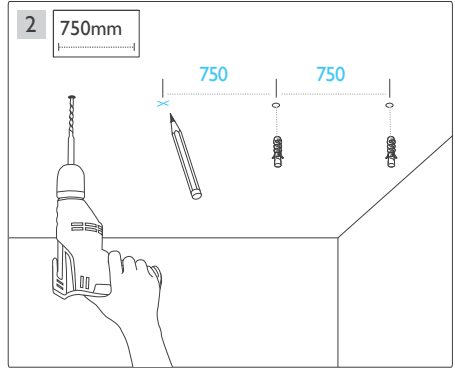
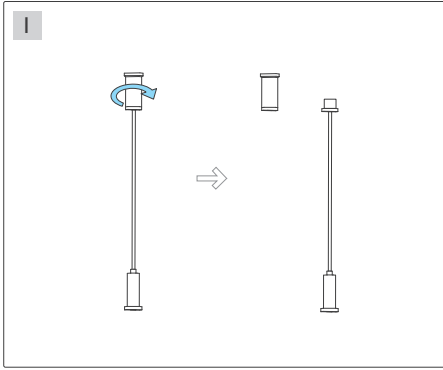

6

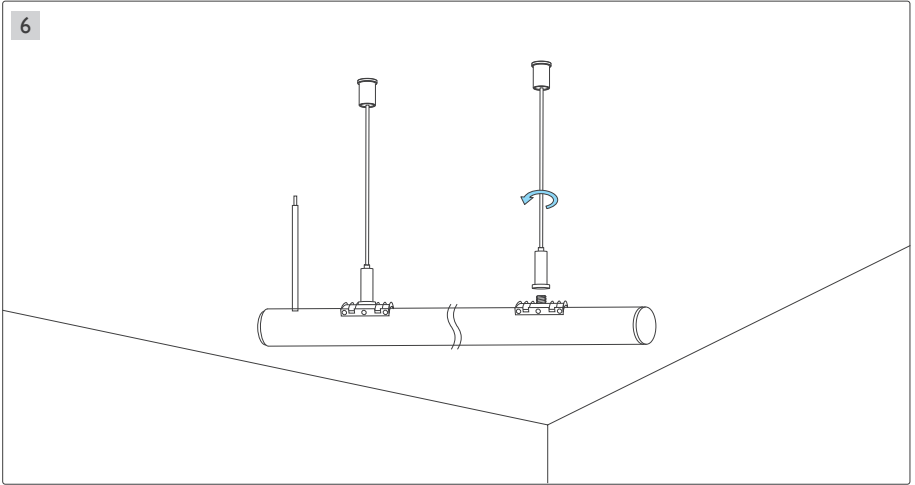

Accessories Installation

NEO 360 shapeable accessories

VI.1

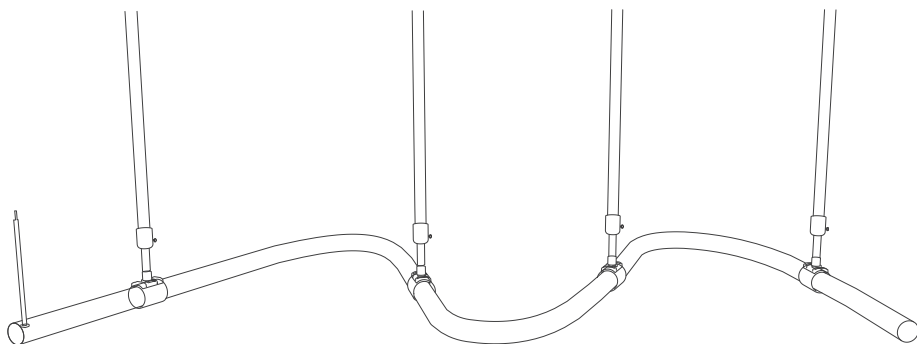

Please read this manual carefully before installation, and install the product in the correct way. Please keep it after reading, so that all users of this product can check it at any time.

Prepare materials

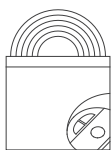

Neo strip



Manual



Rubber plug
screw



Modeling accessories



Telescopic boom

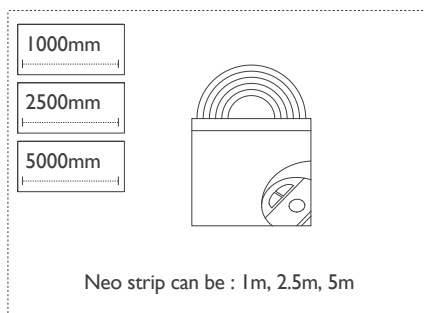
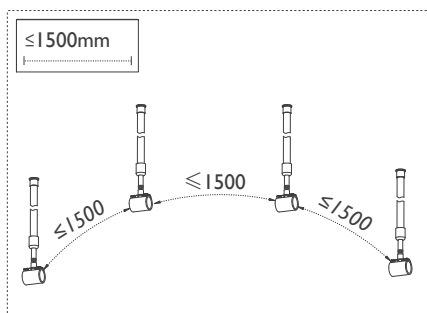

Installation tools



Screwdriver



Pen

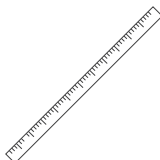

Tape measure

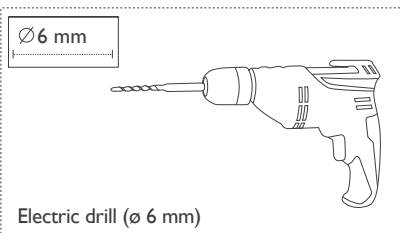

Electric drill ($\varnothing 6\text{ mm}$)



Installation Steps

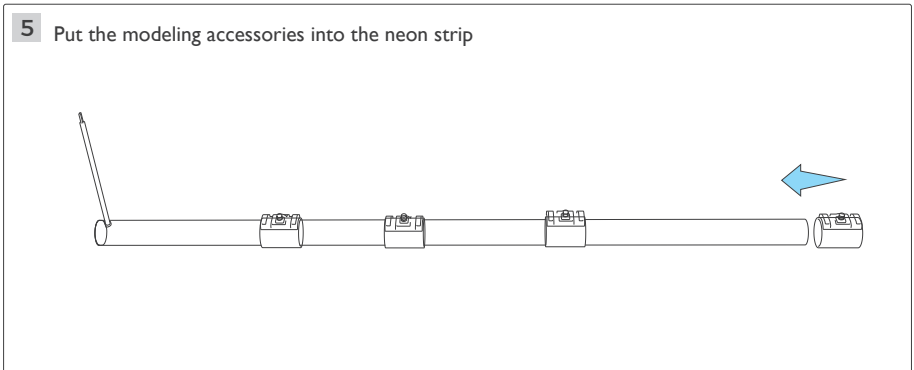
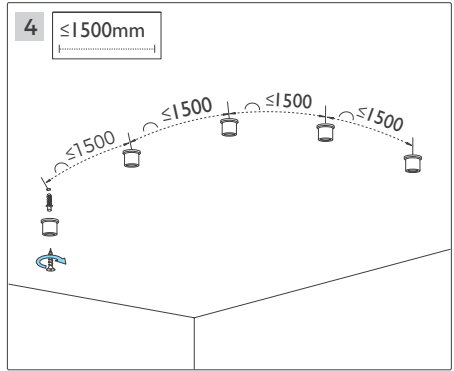
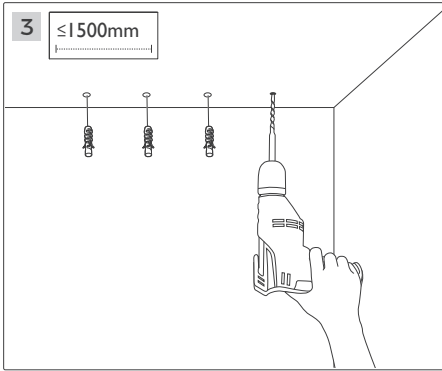
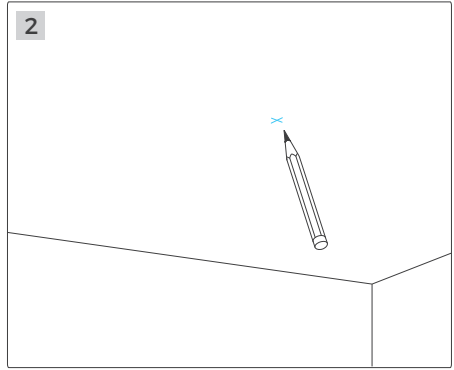
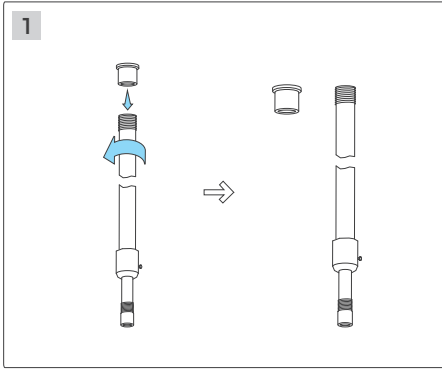

Installation Steps

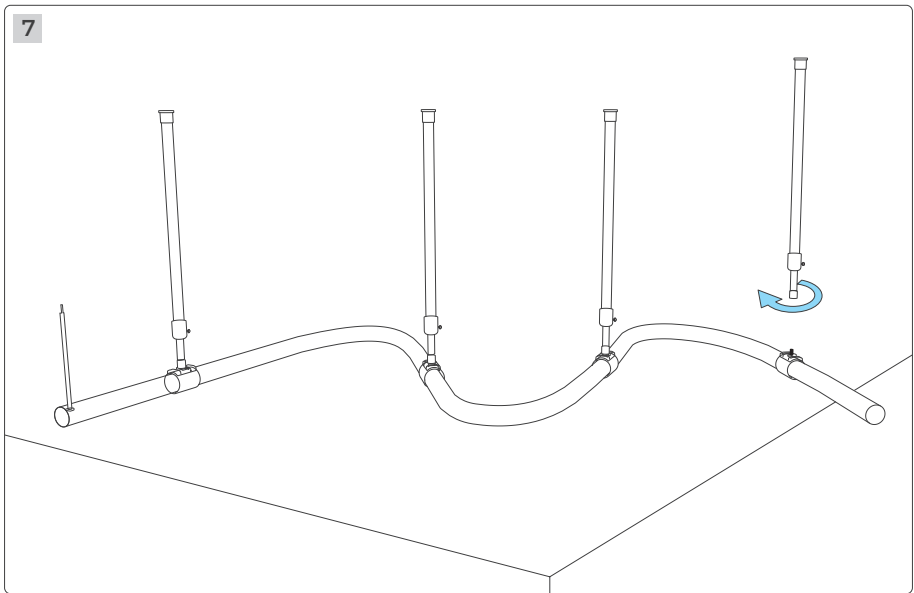
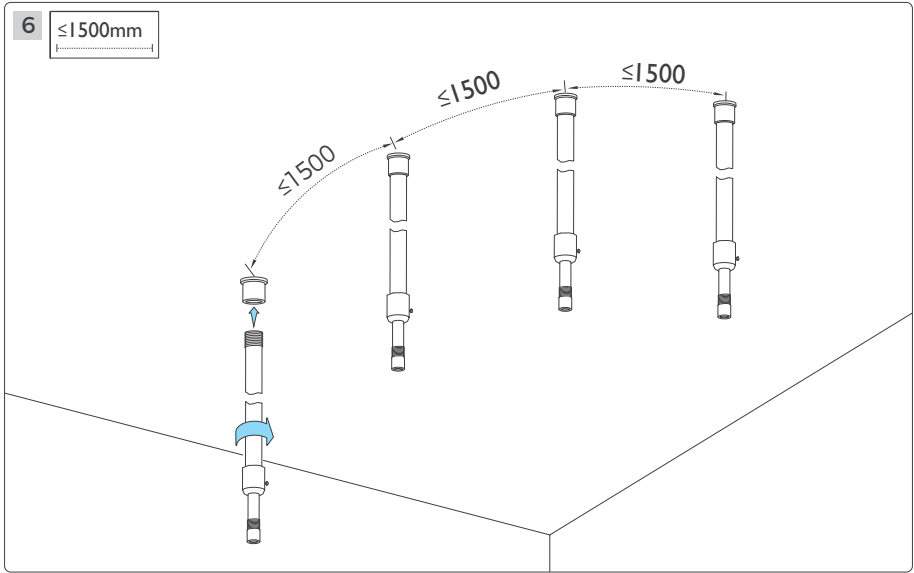

Installation Steps

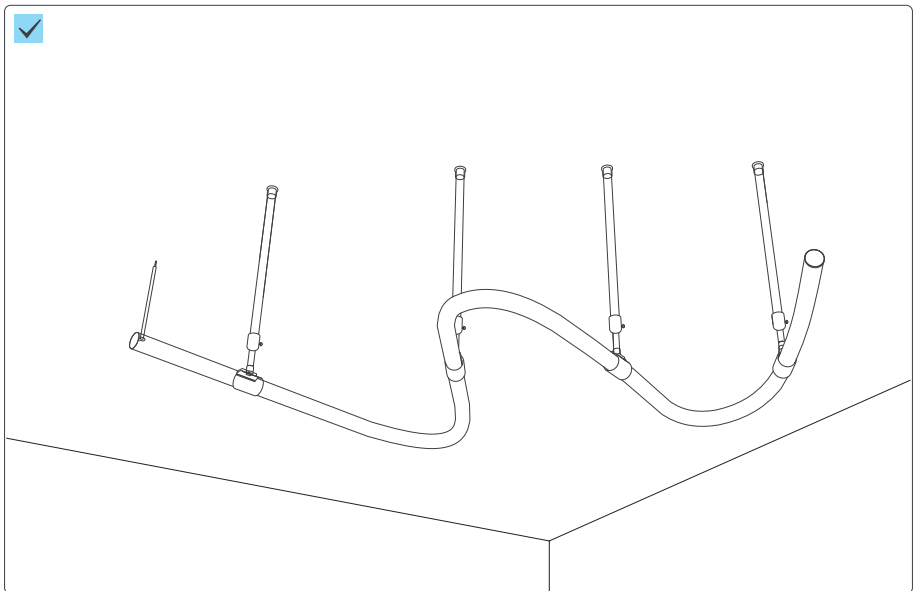
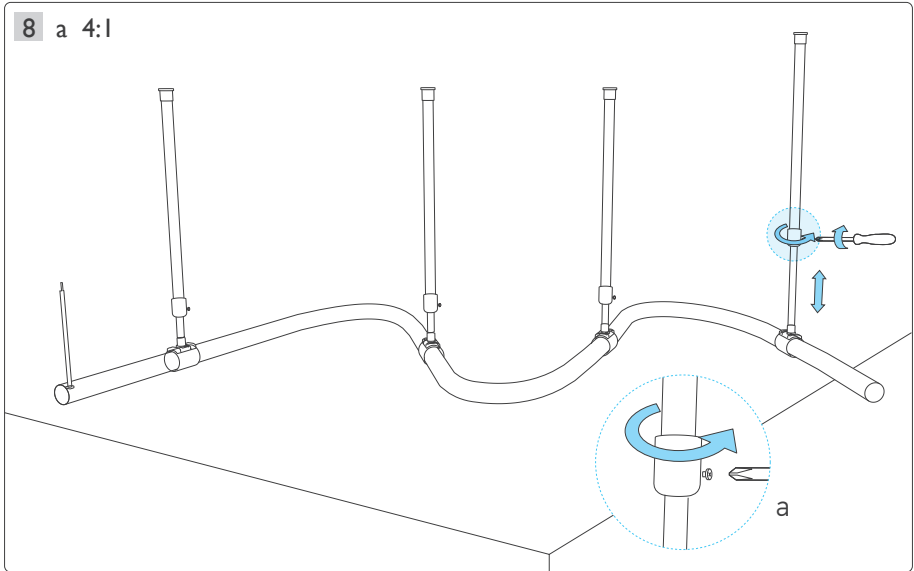

Accessories Installation

Neo 360 Splicing accessories

VI.1

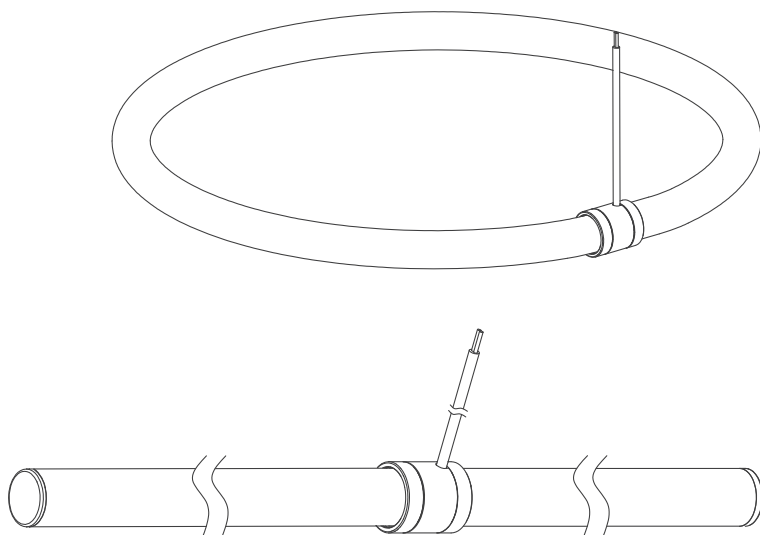

Please read this manual carefully before installation, and install the product in the correct way. Please keep it after reading, so that all users of this product can check it at any time.

Prepare materials

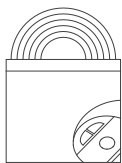

Neo strip



Manual



Countersunk screw

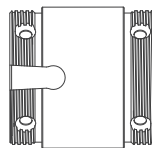

Splicing piece

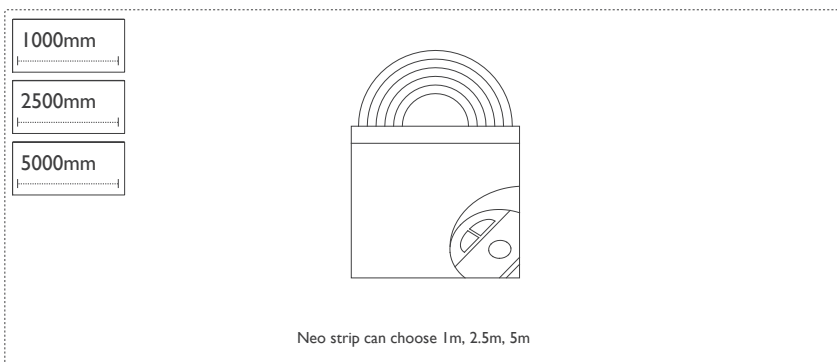

Installation tools



Phillips
screwdriver



Prepare materials

- 1 a 2:l Put the connecting ring into the neo strip

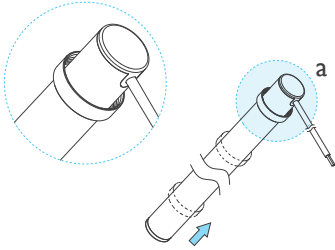

- 2 a 2:l

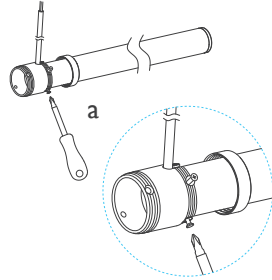

- 3 Screw the connecting ring back to the connecting piece

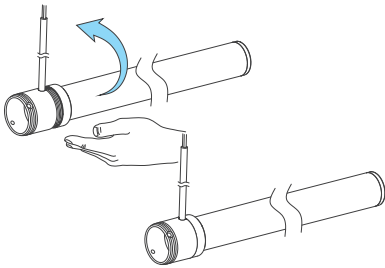

- 4 a 2:l

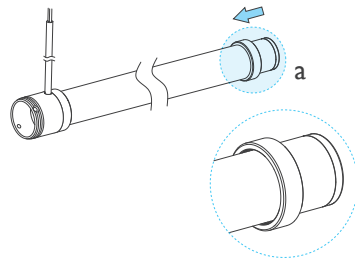

- 5 a 3:l

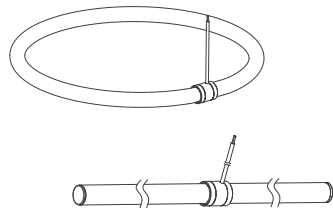
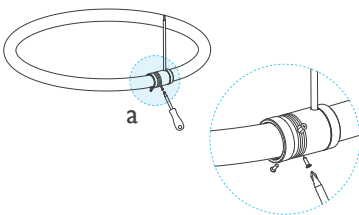

Accessories Installation

Neo 360 Vertical ceiling mounted accessories VI.1

Single Ended

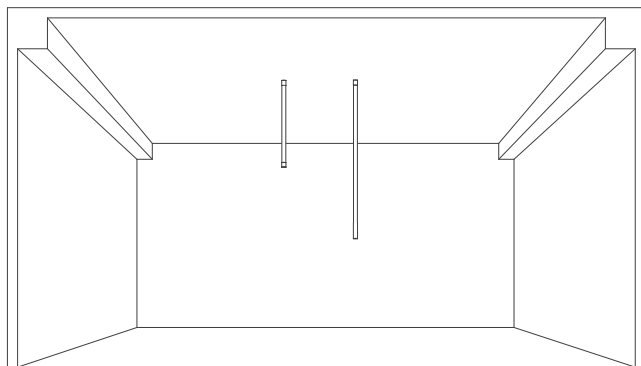

Double Ended

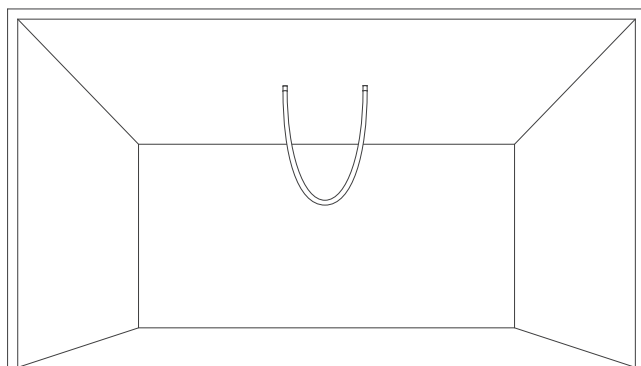

Please read this manual carefully before installation, and install the product in the correct way. Please keep it after reading, so that all users of this product can check it at any time.

Prepare materials- Single Ended



Neo strip



Manual



Rubber plug screw



End capscrew



Countersunk screw



PC tube



Metal accessories



Allen wrench

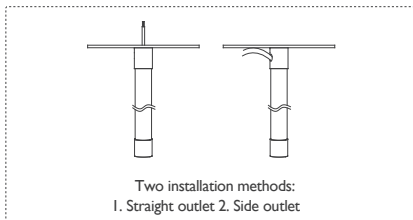

The length of the neo strip and PC tube 1m and 2.5m option

Prepare materials- Double Ended



Neo strip



Manual



Rubber plug screw



Countersunk screw



Metal accessories



Allen wrench

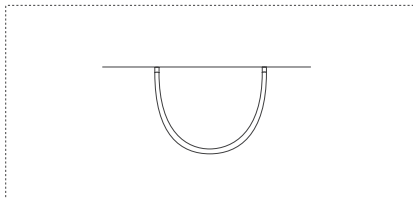

Neo strip can choose 1m, 2.5m, 5m

Installation tools



Phillips screwdriver



Slotted screwdriver



Pen

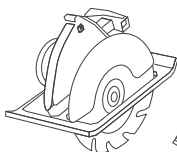

Cutting Machine



Tape measure

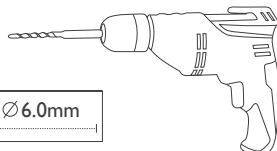

∅6.0mm

Electric drill (head is ø6.0mm)



Installation Steps

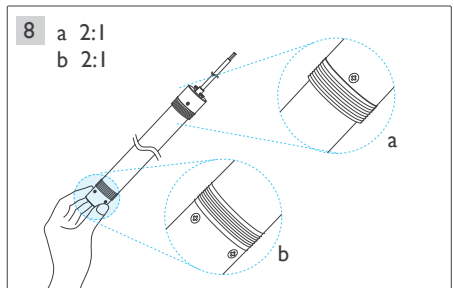
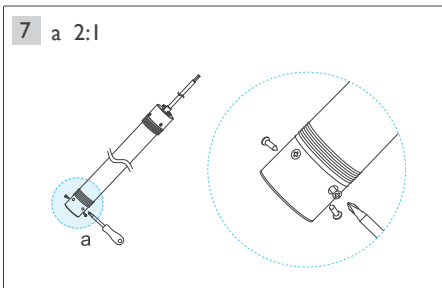
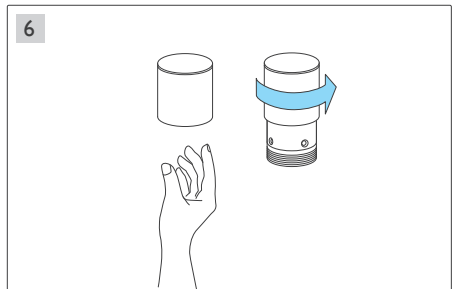
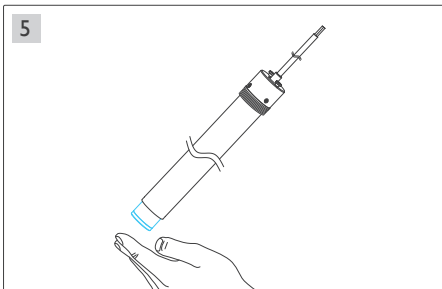
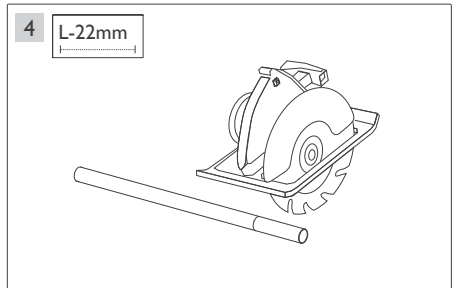
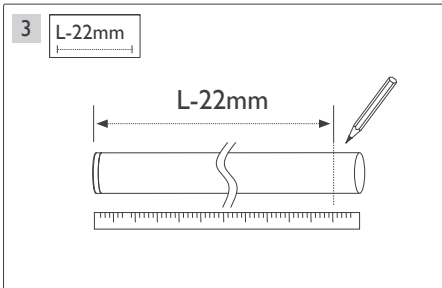
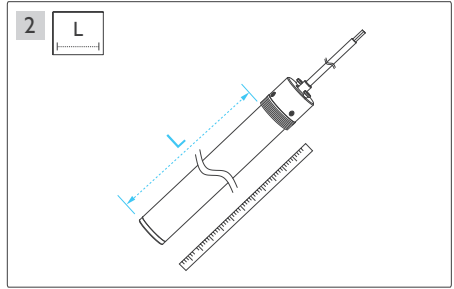
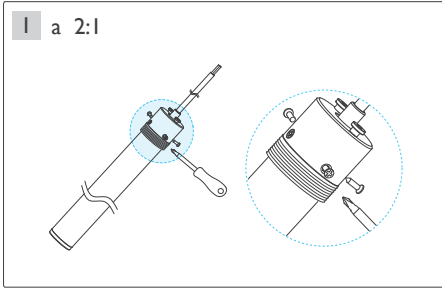

📄 Installation Steps - Single Ended

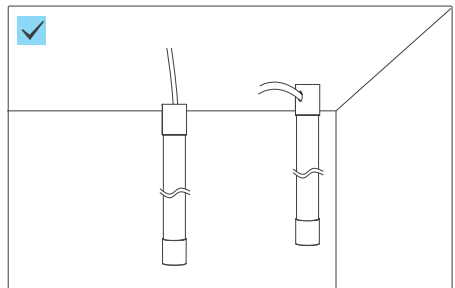
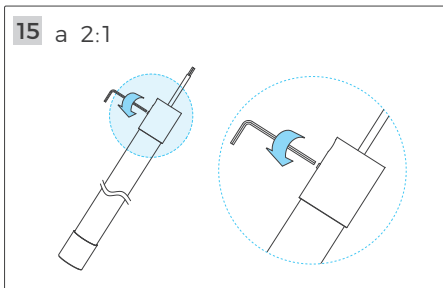
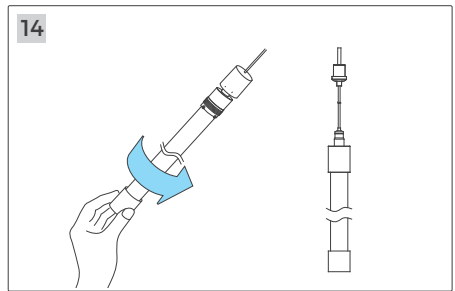
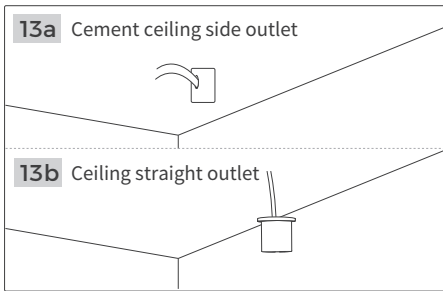
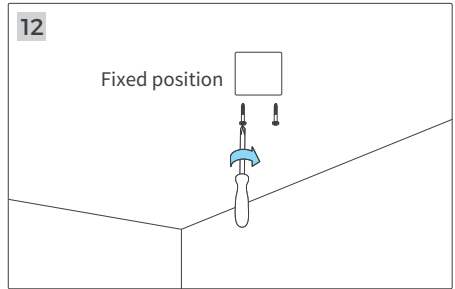
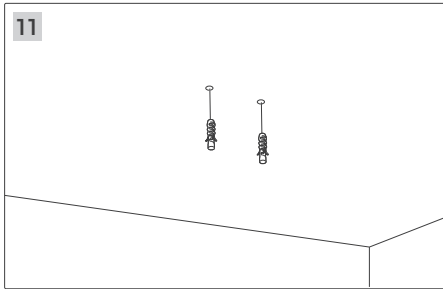
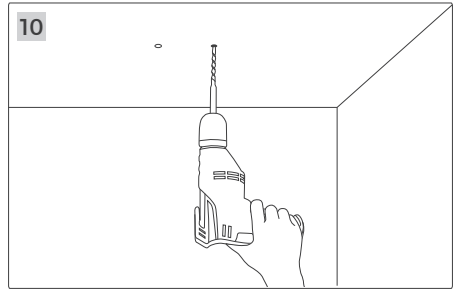
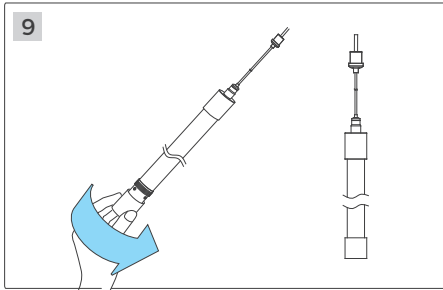



Installation Steps - Double Ended

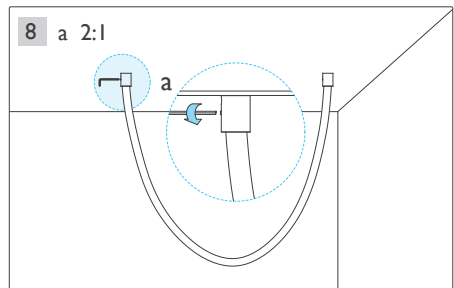
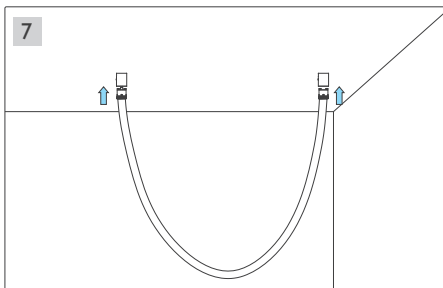
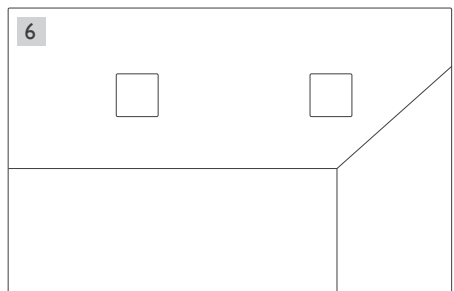
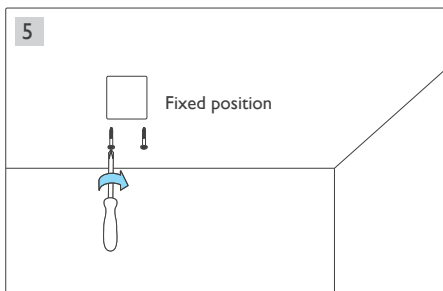
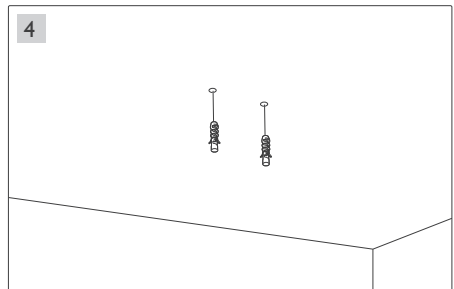
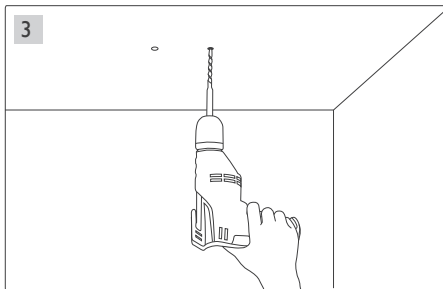
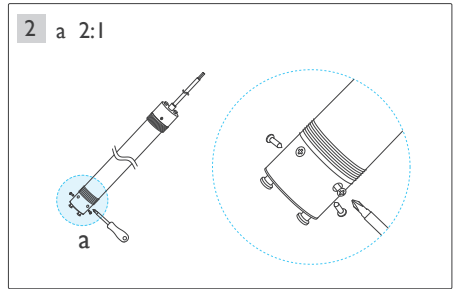
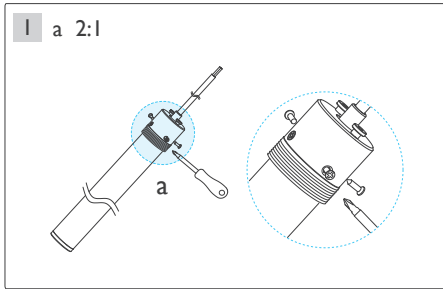

Accessories Installation

Neo 360 Vertical suspension accessories

VI.1



Side/ Cement Ceiling

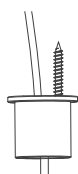
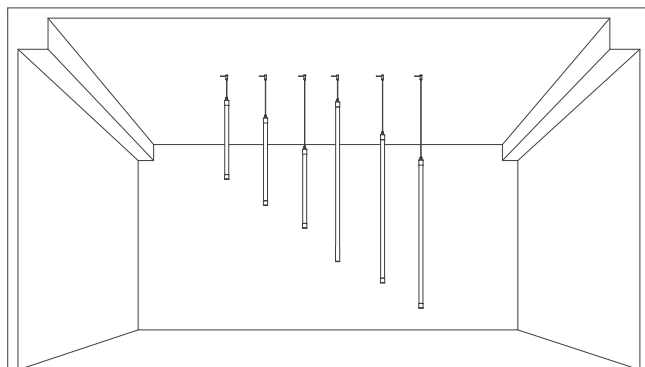

Top/ Suspended Ceiling

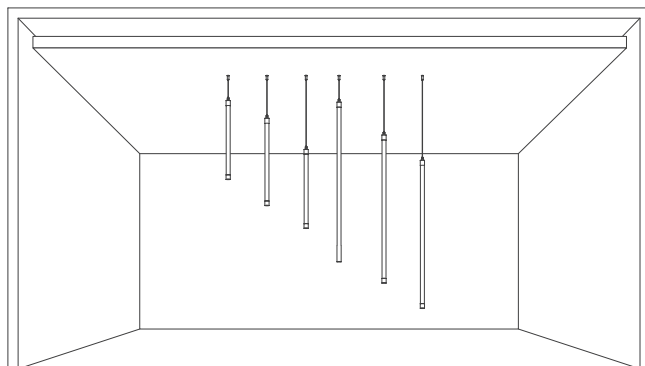

Please read this manual carefully before installation, and install the product in the correct way. Please keep it after reading, so that all users of this product can check it at any time.

Prepare materials



Neo strip



Manual



PC tube



Rubber plug screw



Countersunk screw

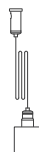

Two-in-one wire

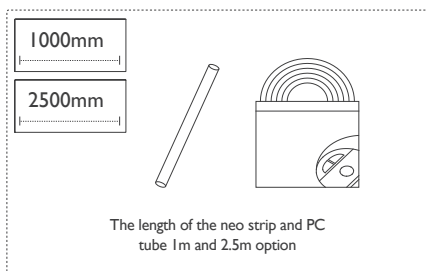
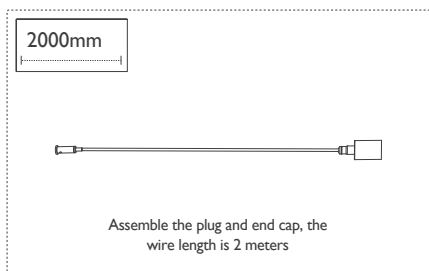

Installation tools



Phillips screwdriver



Slotted screwdriver

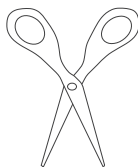

Scissors

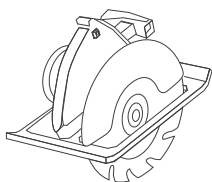
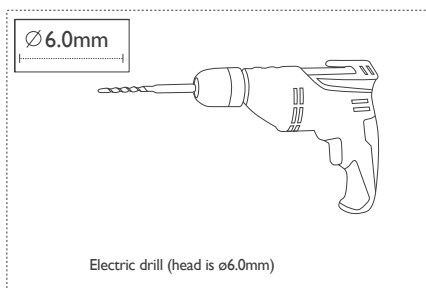

Cutting Machine



Pen



Tape measure

Installation Steps

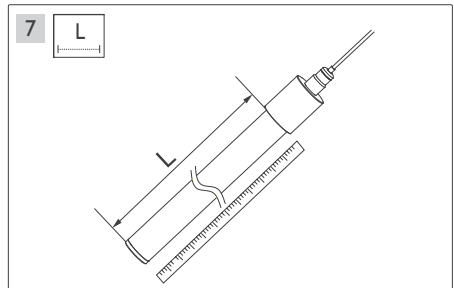
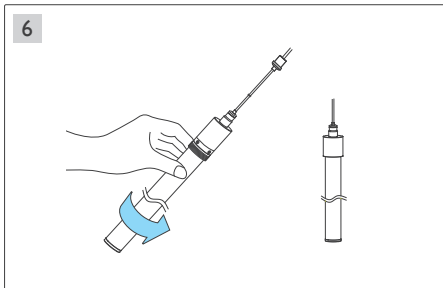
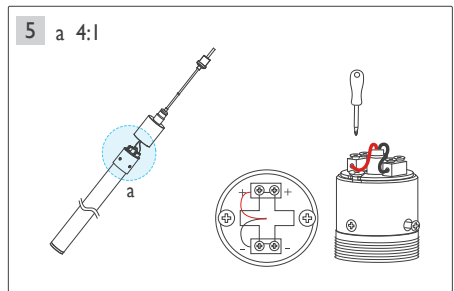
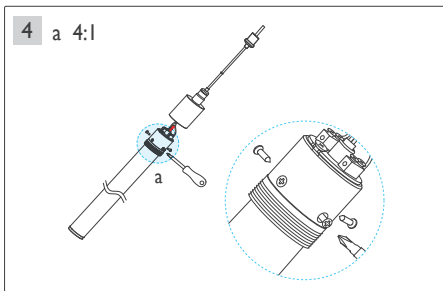
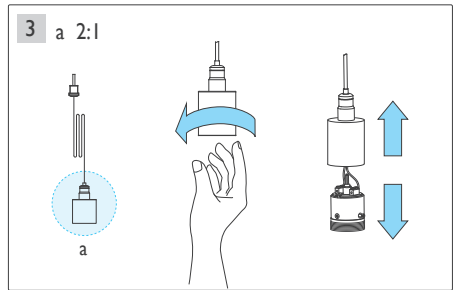
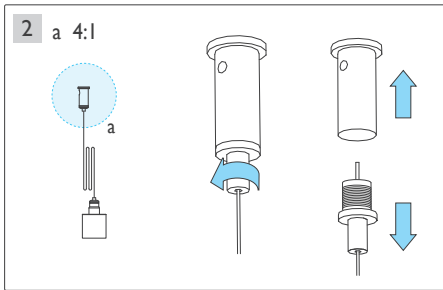
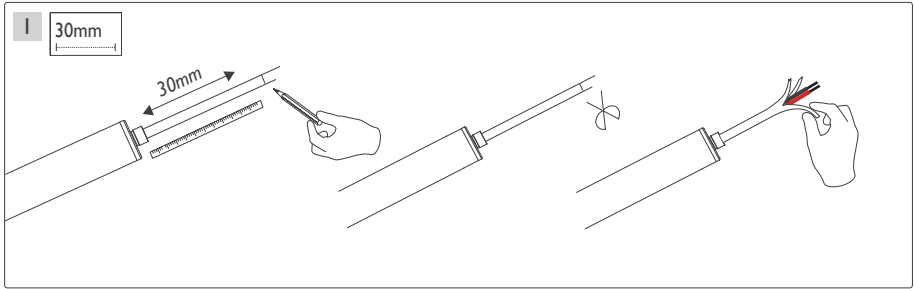

Installation Steps

8 L-22mm The PC tube is 22mm shorter than the light strip

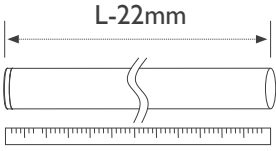

L-22mm

9 L-22mm

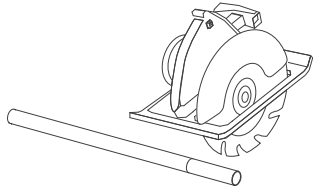

10

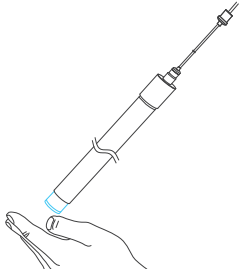

11

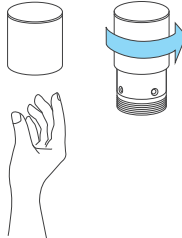

12 a 4:l

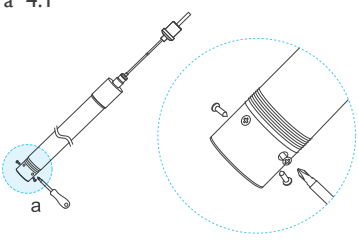

a

13 a 4:l
b 3:l

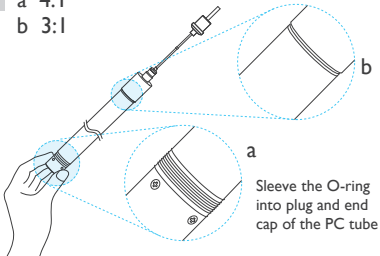

a

b

Sleeve the O-ring into plug and end cap of the PC tube

14

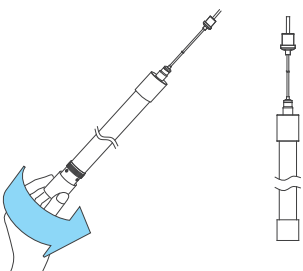

15

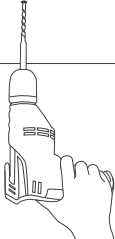

Installation Steps

