

Linear

FLO Pool Fixture Guide

KKDÖ

Outdoor/Underwater | Surface | Output up to 396lm/m (121lm/ft)

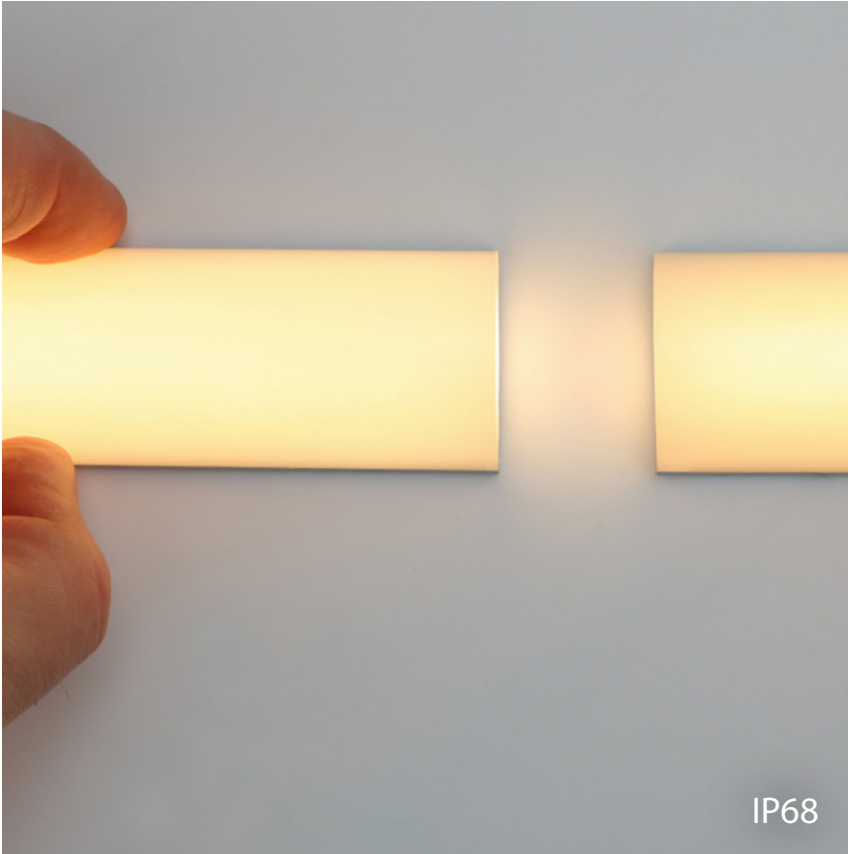

Key applications

- ✓ Architectural detail
- ✓ Bathrooms
- ✓ Cove lighting
- ✓ Exterior
- ✓ Indirect lighting
- ✓ Orientation lighting
- ✓ Pond/Water features
- ✓ Public spaces
- ✓ Swimming pools
- ✓ Wet area

Key features

- ✓ Custom lengths
- ✓ Constant voltage (CV)
- ✓ Continuous light runs
- ✓ Diffusion: homogenous
- ✓ Direct view
- ✓ Extensive CCT range
- ✓ Illuminated ends
- ✓ IP68

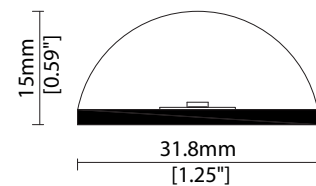

MOUNTING METHODS



KKCP-23 Screw-fix mounting bracket

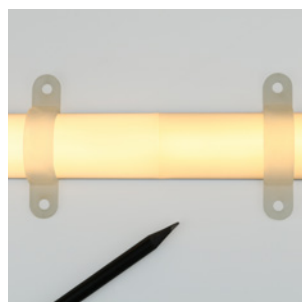

Seamless end to end joining

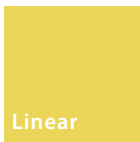

FLO Pool

Specification sheet



Dimensions	H15/W31.75/L129-2004mm (0.59/1.25/5.079-78.9in)
PCB Cut-point	62.5mm increment/2000mm max (2.46in increment/78.74in max)
LED Pitch	10.4mm - 96LED/m (0.41in - 29LED/ft)
Chip	s-line: Toyoda Gosei k-line: Toyoda Gosei or Equivalent
Cover/Optics	Diffused resin (130°)
CCT	s-line: 1900K/2100K/2300K/2500K/2700K/3000K/3500K/4000K/5000K k-line: 1900K/2100K/2300K/2500K/2700K/3000K/3500K/4000K/5000K
LED binning	s-line: 2-step MacAdam ellipse k-line: 3-step MacAdam ellipse
CRI	86
Lifetime	50,000 hours @ 25°C (50,000 hours @ 77°F)
Operating temp	T _a = -25 to 40°C (T _c max = 67°C) T _a = -13 to 104°F (T _c max = 152.6°F)
IP Rating	IP68
Finish	Custom alabaster marble effect resin/Anodized aluminium
Mounting	Screw-fix mounting brackets
Power feed	Hardwire tails or male/female connectors
Control	0-10V/1-10V/DMX/DALI
Warranty	Submerged in Pool 1 year or out of pool 3 years
Submersion Depth	2m max



LED Grading Key

Exclusive Grade

s s-line*	*KKDC tuned CCT range
2-step CCT range	

Base Grade

k k-line	3-step commercial range
	Energy Star CCTs

Power consumption	Supply voltage	Supply current
18W/m (5.49W/ft)	24V DC	0.75A/m (0.23A/m)

Performance Data (3000K)

	R1	R2	R3	R4	R5	R6	R7	R8	R9	R10	R11	R12	R13	R14
s-line	87	90	92	89	86	86	94	81	51	77	88	66	87	95

Diffused

												CRI	R9	Rf	Rg
s-line	396lm/m (121lm/ft)											86	51	-	-
	22lm/W														

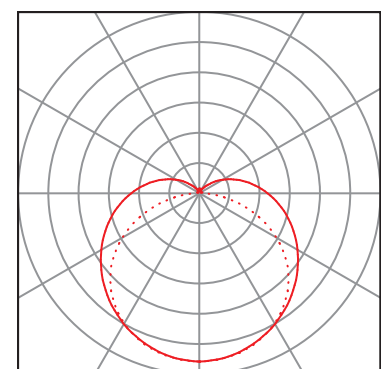
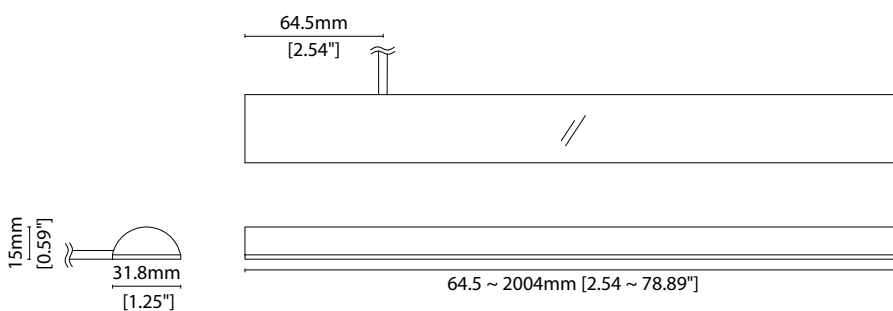

Data derived from independent UKAS / IESNA LM-79-08 accredited testing of production samples.

Fixture Model		Grade ¹		LED	Colour (CCT)		Length Availability ²		IP		Cable Length		Power Feed ³		Input	
FLO Pool	FP	S	s	908	1900K	19	m	129-2004mm 62.5mm increments	IP68	68	3000mm (118.11in)	3000	Single ø4.3mm sheath tail	S00A	DC 24V	g
			k		2100K	21						5000mm (196.85in)				
		k	2300K		23	i	5.08-78.9in 2.46in increments	(Specify length code OR total run length)								
			2500K		25											
			2700K		27											
			3000K		30											
			3500K		35											
			4000K		40											
			5000K		50											

¹ Refer to **LED Grading Key** on **Specification sheet** page

² Refer to **Length Availability List** or enter total run length instead of length code

³ Refer to **Power Feed Options** on **Options** pages

Code Example:

FP	-	S	-	908	-	35	-	m	-	504	-	68	-	3000	-	S00A	-	g
FLO Pool		S		908		3500K				504mm		IP68		3000mm (118.11in)		Single ø4.3mm sheath tail		DC 24V

Accessories

Mounting Accessories

KKCP-23 Screw-fix mounting bracket

* Refer to **Mounting accessories** on **Accessories** pages

PSU/Driver

0-10V/1-10V/DALI/DMX

* Refer to **Driver/PSU Options** page for details or provide requirement and KKDC to offer the suitable option

Length Code		Fixture Length ¹		LED Strip ²		End Cap Dimension		Wattage (W)	Output (lm)
Metric	Imperial(US)	Metric	Imperial(US)	Metric	Imperial(US)	Metric	Imperial(US)		2900K (Test Data)
m0129	i0005	129mm	5.08in	125mm	4.92in	N/A	N/A	2.25	50
m0192	i0008	192mm	7.54in	188mm	7.38in	N/A	N/A	3.38	74
m0254	i0010	254mm	10.00in	250mm	9.84in	N/A	N/A	4.50	99
m0317	i0012	317mm	12.46in	313mm	12.30in	N/A	N/A	5.63	124
m0379	i0015	379mm	14.92in	375mm	14.76in	N/A	N/A	6.75	149
m0442	i0017	442mm	17.38in	438mm	17.22in	N/A	N/A	7.88	173
m0504	i0020	504mm	19.84in	500mm	19.69in	N/A	N/A	9.00	198
m0567	i0022	567mm	22.30in	563mm	22.15in	N/A	N/A	10.13	223
m0629	i0025	629mm	24.76in	625mm	24.61in	N/A	N/A	11.25	248
m0692	i0027	692mm	27.22in	688mm	27.07in	N/A	N/A	12.38	272
m0754	i0030	754mm	29.69in	750mm	29.53in	N/A	N/A	13.50	297
m0817	i0032	817mm	32.15in	813mm	31.99in	N/A	N/A	14.63	322
m0879	i0035	879mm	34.61in	875mm	34.45in	N/A	N/A	15.75	347
m0942	i0037	942mm	37.07in	938mm	36.91in	N/A	N/A	16.88	371
m1004	i0040	1004mm	39.53in	1000mm	39.37in	N/A	N/A	18.00	396
m1067	i0042	1067mm	41.99in	1063mm	41.83in	N/A	N/A	19.13	421
m1129	i0044	1129mm	44.45in	1125mm	44.29in	N/A	N/A	20.25	446
m1192	i0047	1192mm	46.91in	1188mm	46.75in	N/A	N/A	21.38	470
m1254	i0049	1254mm	49.37in	1250mm	49.21in	N/A	N/A	22.50	495
m1317	i0052	1317mm	51.83in	1313mm	51.67in	N/A	N/A	23.63	520
m1379	i0054	1379mm	54.29in	1375mm	54.13in	N/A	N/A	24.75	545
m1442	i0057	1442mm	56.75in	1438mm	56.59in	N/A	N/A	25.88	569
m1504	i0059	1504mm	59.21in	1500mm	59.06in	N/A	N/A	27.00	594
m1567	i0062	1567mm	61.67in	1563mm	61.52in	N/A	N/A	28.13	619
m1629	i0064	1629mm	64.13in	1625mm	63.98in	N/A	N/A	29.25	644
m1692	i0067	1692mm	66.59in	1688mm	66.44in	N/A	N/A	30.38	668
m1754	i0069	1754mm	69.06in	1750mm	68.90in	N/A	N/A	31.50	693
m1817	i0072	1817mm	71.52in	1813mm	71.36in	N/A	N/A	32.63	718
m1879	i0074	1879mm	73.98in	1875mm	73.82in	N/A	N/A	33.75	743
m1942	i0076	1942mm	76.44in	1938mm	76.28in	N/A	N/A	34.88	767
m2004	i0079	2004mm	78.90in	2000mm	78.74in	N/A	N/A	36.00	792

¹ Actual total overall length of light fixture

² Actual length of PCB strip

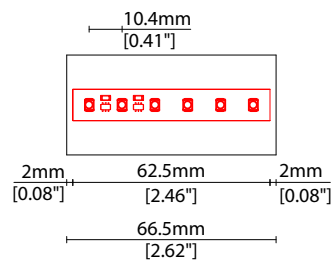

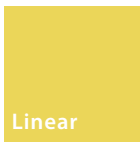

FLO Pool Options



POWER FEED OPTIONS

* Options are an integral part of the fixture ordering codes. Please refer to **Code Table** pages.

3000 S00A 3000mm (118.11") Single ø4.3mm sheath tail

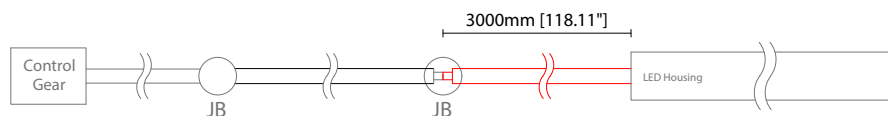

5000 S00A 5000mm (196.85") Single ø4.3mm sheath tail

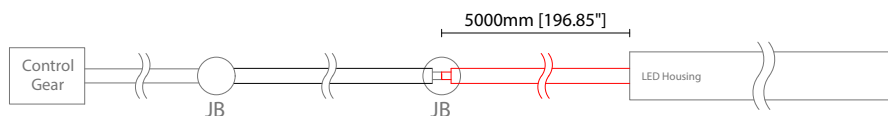

Key

Control Gear Power supply, sub-controllers & control systems

JB Junction box / cable connection

MOUNTING ACCESSORIES

Note: Accessories are to be ordered separately with corresponding code shown below.

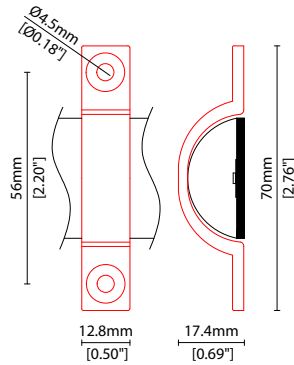

KKCP-23

Screw-fix mounting bracket
(allow 4 per metre/40in)

White plastic

L70/W12.8/H17.4mm
(L2.76/W0.50/H0.69")

KKDC CONTROL



IP20
Plastic housing
L170/W59/H29mm
(L6.69/W2.32/H1.14in)

KKDM-06 1-10V

visDIM dimmable sub-controller
(4 x 8A max @ 12-36V)



IP20
Plastic housing
L170/W53.4/H28mm
(L6.69/W2.10/H1.10in)

KKSC-05 DMX

visDIM dimmable sub-controller
(4 x 5A max @ 12-36V)



IP20
Plastic housing
L170/W59/H29mm
(L6.69/W2.32/H1.14in)

KKDL-02 DALI

visDIM dimmable sub-controller
(4 x 8A max @ 12-36V)



IP20
Plastic housing
L166/W53.4/H23mm
(L6.54/W2.10/H0.91in)

KKDL-03 DALI

visDIM dimmable sub-controller
(4 x 5A max @ 12-36V)

AVAILABLE PSU OPTIONS

Control Mode	PSU (Order Code)	Input Voltage AC	Output Voltage DC	Rated Output Current	Rated Power	Dim %	IP Rating
Switched	CEN-60-24	90-295V	24V	2.5A	60W	-	IP67
	HLG-60H-24	90-305V	24V	2.5A	60W	-	IP67
	HLG-100H-24	90-305V	24V	4.0A	100W	-	IP67
	HLG-150H-24	90-305V	24V	6.3A	150W	-	IP67
	HLG-240H-24	90-305V	24V	10A	240W	-	IP67
0-10V (1-10V)	PWM-40-24	90-305V	24V	1.67A	40W	100-0.15 (100-10)	IP67
	PWM-60-24	90-305V	24V	2.5A	60W	100-0.15 (100-10)	IP67
	PWM-90-24	90-305V	24V	3.67A	90W	100-0.15 (100-10)	IP67
	PWM-120-24	90-305V	24V	5.0A	120W	100-0.15 (100-10)	IP67
DALI	LIN100A1	120-277V	24V	1A per channel	100W	100-0.1	IP66/IP40
DMX RGB	LIN100A1	120-277V	24V	1.33A per channel	100W	100-0.1	IP66/IP40
DMX RGBW	LIN100A1	120-277A	24V	1A per channel	100W	100-0.1	IP66/IP40

Flicker Free Options - Combination of PSU+ sub-controller

Control Mode	PSU (Order Code)	Sub-controller (Order Code)	Input Voltage AC	Output Voltage DC	Rated Output Current	Rated Power	Dim %	IP Rating PSU/ Sub-controller
0-10V or 1-10V	CEN-60-24	KKDM-06	90-295V	24V	2.5A	60W	100-0.9	IP67/IP20
	HLG-60H-24	KKDM-06	90-295V	24V	2.5A	60W	100-0.9	IP67/IP20
	HLG-100H-24	KKDM-06	90-295V	24V	4.0A	100W	100-0.9	IP67/IP20
	HLG-150H-24	KKDM-06	90-295V	24V	6.3A	150W	100-0.9	IP67/IP20
	HLG-240H-24	KKDM-06	90-295V	24V	10.0A	240W	100-0.9	IP67/IP20
DALI	CEN-60-24	KKDL-02/03	90-295V	24V	2.5A	60W	100-0.1	IP67/IP20
	HLG-60H-24	KKDL-02/03	90-305V	24V	2.5A	60W	100-0.1	IP67/IP20
	HLG-100H-24	KKDL-02/03	90-305V	24V	4.0A	100W	100-0.1	IP67/IP20
	HLG-150H-24	KKDL-02/03	90-305V	24V	6.3A	150W	100-0.1	IP67/IP20
	HLG-240H-24	KKDL-02/03	90-305V	24V	10.0A	240W	100-0.1	IP67/IP20
DMX RGB	CEN-60-24	KKSC-05	90-295V	24V	2.5A	60W	100-0.9	IP67/IP20
	HLG-60H-24	KKSC-05	90-305V	24V	2.5A	60W	100-0.9	IP67/IP20
	HLG-100H-24	KKSC-05	90-305V	24V	4A	100W	100-0.9	IP67/IP20
	HLG-150H-24	KKSC-05	90-305V	24V	6.3A	150W	100-0.9	IP67/IP20
	HLG-240H-24	KKSC-05	90-305V	24V	10.0A	240W	100-0.9	IP67/IP20

¹ The items shown above cover the most frequently used specification but does not exhaust the possible options

² PSU and/or driver can be chosen from the table, or KKDC may recommend the best option upon receipt of the controls requirement and installation environment

³ Electrical shop drawing will include detailed information of PSU and relevant control drivers

⁴ Cut sheets are available on the controls section of www.kkdc.lighting or upon request